

Gryphon™ I GBT/GM4500

QUICK REFERENCE GUIDE



General Purpose Handheld
Area Imager Bar Code Reader
with Bluetooth® Wireless Technology or
Datalogic's STAR Cordless System™

 **DATALOGIC**

Datalogic S.r.l.

Via S. Vitalino, 13
40012 Calderara di Reno (BO)
Italy
Tel. +39 051 3147011
Fax +39 051 3147205

©2011-2021 Datalogic S.p.A. and /or its affiliates.

All rights reserved. Without limiting the rights under copyright, no part of this documentation may be reproduced, stored in or introduced into a retrieval system, or transmitted in any form or by any means, or for any purpose, without the express written permission of Datalogic S.p.A. and/or its affiliates.

Owners of Datalogic products are hereby granted a non-exclusive, revocable license to reproduce and transmit this documentation for the purchaser's own internal business purposes. Purchaser shall not remove or alter any proprietary notices, including copyright notices, contained in this documentation and shall ensure that all notices appear on any reproductions of the documentation.

Electronic versions of this document may be downloaded from the Datalogic website (www.datalogic.com). If you visit our website and would like to make comments or suggestions about this or other Datalogic publications, please let us know via the "Contact" page.

Disclaimer

Datalogic has taken reasonable measures to provide information in this manual that is complete and accurate, however, Datalogic shall not be liable for technical or editorial errors or omissions contained herein, nor for incidental or consequential damages resulting from the use of this material. Datalogic reserves the right to change any specification at any time without prior notice.

Trademarks

Datalogic and the Datalogic logo are registered trademarks of Datalogic S.p.A. in many countries, including the U.S.A. and the E.U.

Gryphon is a trademark of Datalogic S.p.A. and/or its affiliates, registered in the U.S. All other trademarks and brands are property their respective owners.

Patents

See www.patents.datalogic.com for patent list.

See the Regulatory Addendum included with your product for additional regulatory, safety and legal information.

TABLE OF CONTENTS

| | |
|--|-----------|
| END USER SOFTWARE LICENSE AGREEMENT..... | V |
| Software Product Policy | X |
| Description | 1 |
| Omni-Directional Operating..... | 1 |
| Decoding..... | 1 |
| Setting Up the Reader | 2 |
| Positioning the Base Station | 3 |
| Reader, Cradle | |
| and LEDs Description..... | 6 |
| Connecting the Base Station | 7 |
| Securing the DC Power Cord (Optional)..... | 8 |
| System and Network Layouts | 10 |
| Stand Alone Layouts..... | 10 |
| Charging the Batteries | 11 |
| The GBT/GM4500 Scanner | 12 |
| Scanner LEDs..... | 12 |
| The WLC4090 Radio Base..... | 13 |
| Radio Base LEDs..... | 13 |
| Using the Gryphon™ I GBT/GM4500 | 14 |
| Aiming System | 14 |
| Relative Size and Location of Aiming Pattern | 14 |
| Linear Bar..... | 15 |
| Relative Size and Location of Green Spot..... | 15 |
| Linking the Reader..... | 16 |
| Link Datalogic Devices to Base | 16 |
| Link Scanner as Serial Device to a Bluetooth Host..... | 16 |
| Link Scanner as HID device to a Bluetooth host | 17 |
| Power Off | 17 |
| Selecting the Interface Type | 18 |
| Interface Selection | 18 |
| Configuring the Interface..... | 19 |
| Keyboard Interface..... | 21 |
| Scancode Tables..... | 22 |
| Country Mode | 22 |
| Programming..... | 26 |
| Using Programming Bar Codes | 26 |
| Configure Other Settings | 26 |
| Resetting Product Defaults | 27 |
| Numlock..... | 27 |

| | |
|---|-----------|
| Caps Lock State | 28 |
| Reading Parameters | 30 |
| Aiming System..... | 30 |
| Good Read Green Spot Duration..... | 30 |
| Operating Modes | 31 |
| Scan Mode..... | 31 |
| Pick Mode | 34 |
| Multiple Label Reading | 34 |
| Technical Specifications | 35 |
| LED and Beeper Indications | 38 |
| Troubleshooting | 39 |
| Warranty | 40 |
| Ergonomic Recommendations | 41 |
| Technical Support | 41 |
| Support Through the Website..... | 41 |
| Reseller Technical Support..... | 41 |
| Cleaning Procedure | 42 |
| Cleaning plastic surfaces..... | 42 |
| Common Cleaning Solutions..... | 42 |
| Cleaning enclosure and window surfaces..... | 44 |
| Replacing the Battery Pack | 45 |
| Battery Safety | 47 |

END USER SOFTWARE LICENSE AGREEMENT

(EULA) FOR THE GRYPHON™ I GBT/GM4500 PRODUCT SERIES

NOTICE TO END USER: BY DOWNLOADING OR INSTALLING THE SOFTWARE, OR BY USING THE DATALOGIC PRODUCT THAT INCLUDES THIS SOFTWARE, THE END USER CONSENTS TO BE BOUND BY THIS AGREEMENT. IF THE END USER DOES NOT AGREE WITH ALL OF THE TERMS OF THIS AGREEMENT, THEN DATALOGIC IS NOT WILLING TO LICENSE THE SOFTWARE AND THE END USER IS NOT ALLOWED TO DOWNLOAD, INSTALL OR USE THE SOFTWARE OR THE DATALOGIC PRODUCT---

This End User License Agreement ("EULA") is between Datalogic IP Tech S.r.l. having its registered office at Via San Vitalino 13, 40012 Calderara di Reno (Bologna), Italy ("Datalogic"), and you, either an individual or a single entity, ("End User or "You") who has purchased one or more GRYPHON™ I GBT/GM4500 ("Datalogic Product") subject to the terms and conditions provided in any relevant purchase or sale contract. This EULA applies to the software contained in the Datalogic Product ("Embedded Software") and to any other software, to the extent applicable, offered as optional application software ("Application Software" that together with "Embedded Software" is herein referred to as "Software"). Any Open Source used in a conjunction with the Software is subject to the Open Source licenses available at the following website: <http://www.datalogic.com/oss>

1. Grant of License

- 1.1 Datalogic grants to End User, a personal, non-exclusive, non-transferable, non sub licensable, revocable, limited license to use the Software, solely on the Datalogic Product in which it is embedded or for which it is intended for use, in machine-readable form only, solely for End User's internal business purposes.
- 1.2 End Users shall not distribute, sublicense, rent, loan, lease, assign, export, re-export, resell, ship or divert or cause to be exported, re-exported, resold, shipped or diverted, directly or indirectly, the Software under this Agreement. End User shall not, and shall not permit others to: (i) modify, translate, decompile, reverse engineer, disassemble, or extract the inner workings of the Software, (ii) copy the functionality of the Datalogic Products; (iii) remove any proprietary notices, marks, labels, or logos from the Datalogic Products; (iv) rent or transfer all or some of the Software to any other party without Datalogic's prior written consent.
- 1.3 Title to the licensed Software shall be and remain with Datalogic or the third party from whom Datalogic has obtained a license right. This Agreement does not grant to End User any intellectual property rights. As used in this Agreement the term "purchase" or its equivalent when applied to the Software shall mean "acquire under license". End User is not entitled to receipt or use of the source code of any licensed Software.
- 1.4 Portions of the Datalogic Product are protected by the relevant and applicable patent and copyright laws, international treaty provisions, and other applicable laws. Therefore, End User must treat the Datalogic Product like any other copyrighted material (e.g., a book or musical recording) except that End User may make one copy of the Software solely for back-up purposes. Unauthorized duplication of the Software constitutes copyright infringement.
- 1.5 Any use of the Software outside of the conditions set forth herein is strictly prohibited and will be deemed a breach of this Agreement resulting in immediate termination of this Agreement. In the event of

a breach of this Agreement, Datalogic will be entitled to all available remedies at law or in equity (including but not limiting to immediate termination of the license without notice, immediate injunctive relief and repossession of all Datalogic Products).

- 1.6 Without prejudice of the foregoing, End User grants to Datalogic and its independent accountants or consultants the right to examine End User's books, records and accounts during End User's normal business hours to verify compliance with this Agreement. In the event such audit discloses non-compliance with this Agreement, Datalogic shall be entitled to immediately terminate the Agreement, request End User to promptly pay all (additional) license fees due and any further damages, if any.

2. License Fee

License fees shall be due by End User to Datalogic according to the terms provided for in the relevant contract for the purchase of the Datalogic Product.

3. Termination

Without prejudice to any other rights or remedies Datalogic may have, Datalogic may terminate this Agreement if End User fails to comply with the terms and conditions of this Agreement. Datalogic may terminate this Agreement by offering you a superseding Agreement for the Software or any replacement or modified version of or upgrade to the Software and conditioning your continued use of the Software or such replacement, modified or upgraded version on your acceptance of such superseding Agreement. In addition, either party may terminate this Agreement at any time. Subject to the foregoing, termination shall be effective upon notice to the other party. In the event that this Agreement terminates for any reason, End User's license to use the Software will immediately terminate, and End User must immediately stop using the Software, destroy all copies of the Software and all of its component parts, and, upon request, provide an affidavit certifying your compliance with the foregoing. The provisions of Sub-sections 1.2, 1.3, 1.4, 1.5, 4, 5, 6, 8, and 11 shall survive termination of this Agreement.

4. Limited Warranty

Datalogic warrants that, under normal use and operation, the Software will conform substantially to the applicable Datalogic Product documentation for the period specified in the same, provided that the Software is used with the Datalogic Product. Datalogic's entire liability and End User's sole and exclusive remedy for any breach of the foregoing limited warranty will be, at Datalogic's option, the provision of a downloadable patch or replacement software.

Datalogic does not warrant (i) that Software will meet End User's requirements; (ii) that Software will be uninterrupted or defect error free; (iii) any non conformity derived from unauthorized use, and/or improper installation or repair not in compliance with Datalogic Product documentation. End User agrees that the existence of such non conformities or errors and Datalogic's inability to remedy such errors shall not constitute a breach of this Agreement.

EXCEPT AS PROVIDED IN THIS AGREEMENT, THE DATALOGIC PRODUCT IS PROVIDED "AS IS" AND DATALOGIC MAKES NO WARRANTIES OF ANY KIND, EXPRESS OR IMPLIED, WRITTEN OR ORAL, WITH RESPECT TO THE DATALOGIC PRODUCT OR SOFTWARE, AND SPECIFICALLY DISCLAIMS THE IMPLIED WARRANTIES OF MERCHANTABILITY AND FITNESS FOR A PARTICULAR PURPOSE.

5. Limitation of Liability

EXCEPT AS PROVIDED IN THIS AGREEMENT, NEITHER DATALOGIC NOR ITS LICENSORS SHALL BE LIABLE FOR ANY CLAIMS AGAINST END USER BY ANY OTHER PARTY. IN NO EVENT SHALL DATALOGIC'S LIABILITY FOR DAMAGES, IF ANY, WHETHER BASED UPON CONTRACT, TORT (INCLUDING NEGLIGENCE), PRODUCT LIABILITY, STRICT LIABILITY, WARRANTY, OR ANY OTHER BASIS, EXCEED THE PRICE OR FEE PAID BY END USER FOR THE DATALOGIC PRODUCT. UNDER NO CIRCUMSTANCES SHALL DATALOGIC OR ITS LICENSORS BE LIABLE TO END USER OR ANY THIRD PARTY FOR LOST PROFITS, LOST DATA, INTERRUPTION OF BUSINESS OR SERVICE, OR FOR ANY OTHER SPECIAL, CONSEQUENTIAL, CONTINGENT, INDIRECT, INCIDENTAL, PUNITIVE, EXEMPLARY, OR OTHER SIMILAR DAMAGES, EVEN IF DATALOGIC OR ITS LICENSORS HAVE BEEN ADVISED OF THE POSSIBILITY OF SUCH DAMAGES. END USER MUST BRING ANY ACTION UNDER THIS AGREEMENT WITHIN 12 (TWELVE) MONTHS AFTER THE CAUSE OF ACTION ARISES.

6. Indemnification

To the maximum extent permitted by law, End User agrees to defend, indemnify and hold harmless Datalogic, its affiliates and their respective directors, officers, employees and agents from and against any and all claims, actions, suits or proceedings, as well as any and all losses, liabilities, damages, costs and expenses (including reasonable attorney's fees) arising out of or accruing from or related to Licensee's failure to comply with the terms of this Agreement, including but not limited to (1) non compliance with any applicable laws or regulations with Datalogic product documentation, (2) unauthorized use or disclosure of Software, and (3) use of Software in combination with software, hardware, systems, or other items not provided by Datalogic.

7. Support

End User may request support for Software from Datalogic at Datalogic's standard support fees and under Datalogic's standard support terms and conditions in effect at the time the support is requested.

8. Government Restricted Rights; International Use

- 8.1 Use, duplication, or disclosure of the Software by the U.S. Government is subject to the restrictions for computer software developed at private expense as set forth in the U.S. Federal Acquisition Regulations at FAR 52.227-14(g), or 52.227-19 or in the Rights in Technical Data and Computer Software clause at DFARS 252.227-7013(c)(1)(ii), whichever is applicable.
- 8.2 If End User is using the Datalogic Product outside of the United States, End User must comply with the applicable local laws of the country in which the Datalogic Product is used and with U.S. export control laws. Without prejudice of the foregoing, the End User agrees to not export or re-export the Software, any part thereof, or any process or service that is the direct product of the Software to any country, person or entity subject to U.S. export restrictions. End User specifically agrees not to export or re-export any of the Software: (i) to any country to which the U.S. has embargoed or restricted the export of goods or services or to any national of any such country, wherever located, who intends to transmit or transport the Software back to such country; (ii) to any person or entity who you know or have reason to know will utilize the Software in the design, development or production of nuclear, chemical or biological weapons; or (iii) to any person or entity who has been prohibited from participating in U.S. export transactions by any federal agency of the U.S. government. End User warrants and represents that neither the U.S. Commerce Department, Bureau of Export

Administration nor any other U.S. federal agency has suspended, revoked or denied its export privileges.

9. Third Party Software

The Datalogic Product may contain one or more items of third party software which use is governed by separate third party license, unless otherwise stated.

10. Open Source Software

Portions of the Software include or operate with Open Source software ("Open Source Software").

Open Source Software is software covered by a publicly available license governed solely under Copyright law, whereas the complete terms and obligations of such license attach to a licensee solely through the act of copying, using and/or distributing the licensed software, such obligations often include one or more of attribution obligations, distribution obligations, copyleft obligations, and intellectual property encumbrances. The use of any Open Source Software is subject to the terms and conditions of this Agreement as well as the terms and conditions of the corresponding license of each Open Source Software package. If there is a conflict between the terms and conditions of this Agreement and the terms and conditions of the Open Source Software license, the applicable Open Source Software license will take precedence. Datalogic is required to reproduce the software licenses, acknowledgments and copyright notices as provided by the authors and owners, thus, all such information is provided in its native language form, without modification or translation. Please reference and review the above mentioned information to identify which Open Source Software packages have source code provided or available.

11. Notices

All notices required or authorized under this Agreement shall be given in writing, and shall be effective when received, with evidence of receipt. Notices to Datalogic shall be sent to the attention of Datalogic IP Tech S.r.l., Legal & IP Department, Via San Vitalino 13, 40012 Calderara di Reno (Bologna), Italy, or such other address as may be specified by Datalogic in writing.

12. General Provisions

- 12.1 Entire Agreement; Amendment. This document contains the entire agreement between the parties relating to use of the Datalogic Products and the licensing of the Software and supersedes all prior or contemporaneous agreements, written or oral, between the parties concerning the use of the Datalogic Products and licensing of the Software. This Agreement may not be changed, amended, or modified except by written document signed by Datalogic.
- 12.2 Waiver. A party's failure to enforce any of the terms and conditions of this Agreement shall not prevent the party's later enforcement of such terms and conditions.
- 12.3 Governing Law; Venue: End User agrees to the application of the laws of the country in which End User obtained the license to govern, interpret, and enforce all of End User's and Datalogic's respective rights, duties, and obligations arising from, or relating in any manner to, the subject matter of this Agreement, without regard to conflict of law principles. The United Nations Convention on Contracts for the International Sale of Goods does not apply.

All rights, duties, and obligations are subject to the courts of the country in which End User obtained the license. For licenses granted by Licensee who operates in the countries specified below, the following terms apply.

For Americas:

This Agreement is governed by the laws of the State of Oregon. This Agreement and the rights of the parties hereunder shall be governed by and construed in accordance with the laws of the State of Oregon U.S.A, without regard to the rules governing conflicts of law. The state or federal courts of the State of Oregon located in either Multnomah or Lane counties shall have exclusive jurisdiction over all matters regarding this Agreement, except that Datalogic shall have the right, at its absolute discretion, to initiate proceedings in the courts of any other state, country, or territory in which End User resides, or in which any of End User's assets are located. In the event an action is brought to enforce the terms and conditions of this Agreement, the prevailing party shall be entitled to reasonable attorneys' fees, both at trial and on appeal.

For Europe, Middle East and Africa:

This Agreement is governed by the laws of Italy. This Agreement and the rights of the parties hereunder shall be governed by and construed in accordance with the laws of Italy, without regard to the rules governing conflicts of law. Italian Court of Bologna shall have exclusive jurisdiction over all matters regarding this Agreement, except that Datalogic shall have the right, at its absolute discretion, to initiate proceedings in the courts of any other state, country, or territory in which End User resides, or in which any of End User's assets are located. In the event an action is brought to enforce the terms and conditions of this Agreement, the prevailing party shall be entitled to reasonable attorneys' fees, both at trial and on appeal.

For Asia- Pacific Countries:

The validity, interpretation and construction of the Agreement shall be governed by and construed in accordance with Laws of the Republic of Singapore. Parties expressly disclaim the application of the United Nations Convention for International Sale of Goods.

Any dispute arising out of or in connection with this contract, including any question regarding its existence, validity or termination, shall be referred to and finally resolved by arbitration administered by the Singapore International Arbitration Centre ("SIAC") in accordance with the Arbitration Rules of the Singapore International Arbitration Centre ("SIAC Rules") for the time being in force, which rules are deemed to be incorporated by reference in this clause. The seat of the arbitration shall be Singapore.

The number of arbitrators will be three, with each side to the dispute being entitled to appoint one arbitrator. The two arbitrators appointed by the parties will appoint a third arbitrator who will act as chairman of the proceedings. Vacancies in the post of chairman will be filled by the president of the SIAC. Other vacancies will be filled by the respective nominating party. Proceedings will continue from the stage they were at when the vacancy occurred. If one of the parties refuses or otherwise fails to appoint an arbitrator within 30 days of the date the other party appoints its, the first appointed arbitrator will be the sole arbitrator, provided that the arbitrator was validly and properly appointed. All proceedings will be conducted, including all documents presented in such proceedings, in the English language. The English language version of these terms and conditions prevails over any other language version.

12.4 Attorneys' Fees. In the event an action is brought to enforce the terms and conditions of this Agreement, the prevailing party shall be entitled to reasonable attorneys' fees, both at trial and on appeal.

- END -

Software Product Policy

Datalogic reserves the right to ship its products with the latest version of software/firmware available. This provides our customers with the very latest in Datalogic software technology.

The only exception to this policy is when the buyer has a signed contract with Datalogic that clearly defines the terms and conditions for making software/firmware changes in products shipped to the buyer.

To arrange for a Software Maintenance and Support Agreement please contact your Datalogic sales person.

GRYPHON™ GBT/GM4500

DESCRIPTION

The Gryphon™ product series from Datalogic has been perceived as one of the most innovative readers since the beginning and the new generation of 4500 series wireless readers reinforce this concept thanks to the battery wireless charging system that, coupled with an outstanding design, unchallenged ergonomics and a rich feature set, bring the Datalogic Gryphon GM/GBT4500 series to the TOP of hand held scanners for general purpose applications.

On top of contactless recharging, the high-resolution Mega Pixel sensor for outstanding reading results coupled with Datalogic's distinctive warm-white illumination technology, the high visible red 4-dot and aimer and the Datalogic Motionix™ motion-sensing technology will represent additional key elements for the operators who will find the Gryphon GM/GBT4500 extremely easy to use and intuitive in the Retail, Manufacturing, Transportation & Logistics and Healthcare industries.

Omni-Directional Operating

To read a symbol or capture an image, simply aim the reader and pull the trigger. The Gryphon™ I GBT/GM4500 is a powerful omni-directional reader, so the orientation of the symbol is not important. Datalogic's exclusive patented 'Green Spot' for good-read feedback helps to improve productivity in noisy environments or in situations where silence is required. When positioning the product into the stand, the magnetic coupling will make the scanner automatically detect a bar code inside the field of view, and switch the reading system from trigger mode to autosense mode.

Decoding

The Gryphon™ I GBT/GM4500 reliably decodes all standard 1D (linear) and 2D bar codes, including GS1 DataBar™ linear codes, Postal Codes (China Post), Stacked Codes (such as GS1

DataBar Expanded Stacked, GS1 DataBar Stacked, GS1 DataBar, Stacked Omnidirectional). The data stream - acquired from decoding a symbol - is rapidly sent to the host. The reader is immediately available to read another symbol.

SETTING UP THE READER

Follow the steps below to connect and get your reader up and communicating with its host.

1. Configure the Base Station starting on this page.
2. Charge the Batteries (see page 11).
3. Link to the Base Station (see page 16).
4. Select the Interface Type (see page 18).
5. Configure the Reader starting on page 19 (optional, depends on settings needed)



NOTE: According to recent modification of Regulation for shipping Li-Ion based battery packs, the products and their spare battery packs parts are shipped with a very low residual charge (low state of charge).

Hence the needs:

- **that a new product must be fully recharged before starting to use it.**

and

- **that battery packs of the stocked products GBT/GM4500 and spare battery pack parts must be periodically recharged. For instance, by using a WLC4090 cradle powered up with a 12V Datalogic AC/DC adapter (cod.8-0935) for at least 30 minutes each 3 months.**

Positioning the Base Station

The base station/charger may be set up in desk application to hold the reader in two different positions, either a horizontal or vertical position, in order to provide the most comfortable use depending on the needs.

Figure 1 - Horizontal Position



This position is preferred, unless a different specific positioning is required, for its outmost ease of insertion as well as the minimum effort and attention required to customer when docking the scanner.

Figure 2 - Presentation Position



This position is preferred if the scanner is to be used in stand mode and not needed to be often removed from base station.

Figure 3 - Vertical Position



This position is preferred when lack of room on the desk-top recommends the scanner to be left vertical during recharging.

1. Insert the appropriate parts for the desired base station position.
2. Release the screw situated on the bottom of the cradle's base (the screw will be kept in position by the blue ring).

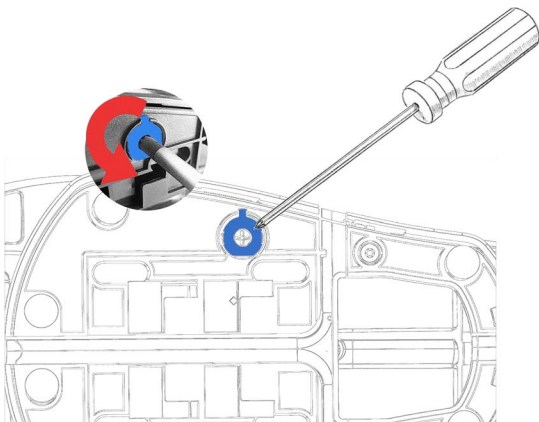

- Using your thumbs, push open the plastic tabs on the bottom of the base to free the wing holders.



- The stand can now be repositioned in either horizontal or standing position.



NOTE: To improve the robustness (against accidental falls) of the cradle in Presentation Position, it is suggested to add the Shock Absorber addendum as illustrated below.

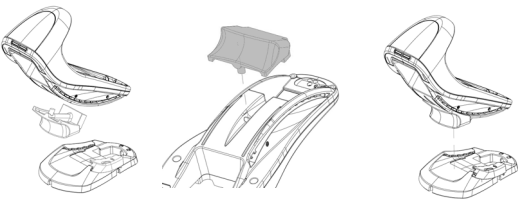

READER, CRADLE AND LEDs DESCRIPTION

LEDs on the gun provide information about the battery charging status as well as data transmission.

Figure 4 - Gryphon Base LEDs

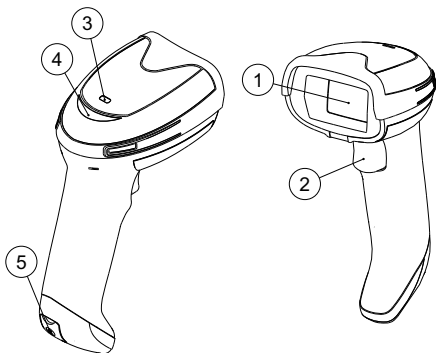

- | | |
|---------------------------|------------------|
| 1. Scan Window | 2. Trigger |
| 3. Battery & Recharge LED | 4. Good Read LED |
| 5. USB Port | |

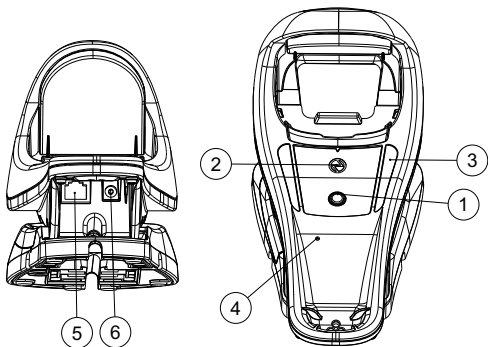

- | | |
|-----------------------|-----------------------|
| 1. Service Button | 2. Power LED |
| 3. Recharge LEDs | 4. Cable Release Hole |
| 5. Communication Port | 6. Aux Power Port |

CONNECTING THE BASE STATION

Figure 5 shows how to connect the Base Station to a terminal, PC or other host device. Turn off the host before connection and consult the manual for that equipment (if necessary) before proceeding. Connect the interface cable before applying power to the Base Station.



NOTE: The Gryphon GBT/GM4500 can also be Powered by the Terminal. When powered by the Terminal, the battery charger is automatically set as Slow charge.

For some specific interfaces or hosts or lengths of cable, the use of an external power supply is recommended for full recharging capability (see "Technical Specifications" on page 35 for more details).

Base Station Connection and Routing — Fully insert the Power Cable and Interface (I/F) Cable connectors into their respective ports in the underside of the Base Station. Then connect to an AC Adapter, and plug the AC power cord into the (wall) outlet.

Figure 5 - Connecting the Base Station

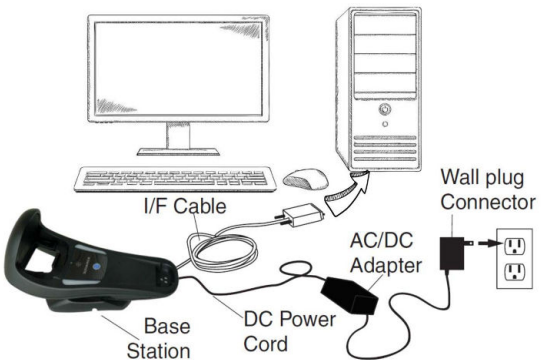

Securing the DC Power Cord (Optional)

The DC power cord for the adapter can be secured to the bottom of the base in order to maximize the mechanical retention of the cable itself. The routing of the power cord can be changed to accommodate base station positioning: horizontal, stand or wall mount. The cables can be looped around to the front of the Base Station, or fed directly out the back of the Base Station, as shown in [Figure 6](#).

Figure 6 - Options for routing the DC cord



Host Connection — Verify before connection that the reader's cable type is compatible with your host equipment. Most connections plug directly into the host device as shown in [Figure 7](#). Keyboard Wedge interface cables have a 'Y' connection where its female end mates with the male end of the cable from the keyboard and the remaining end at the keyboard port on the terminal/PC.

Figure 7 - Connecting to the Host



Power Connection — Plug the AC Adapter into an approved AC wall socket with the cable facing downwards (as shown in [Figure 5](#)) to prevent undue strain on the socket.

Disconnecting the Cable — To detach the cable, insert a paper clip or similar object into the hole on the base, as shown.

Figure 8 - Disconnecting the Cable



SYSTEM AND NETWORK LAYOUTS

Stand Alone Layouts

Figure 9 - Single Reader Layout

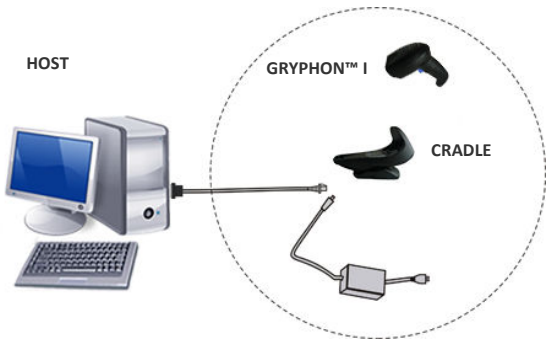
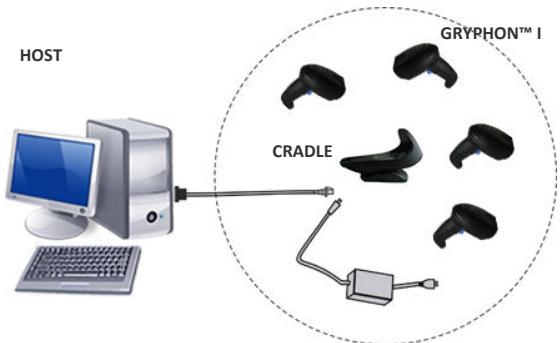
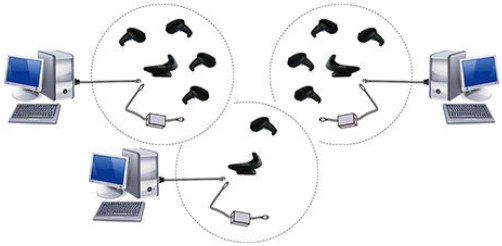

Figure 10 - Multiple Reader Layout



In stand alone systems, each cradle is connected to a single Host.

Figure 11 - Multiple Stand Alone Layout

Many stand alone connections can operate in the same physical area without interference, provided all readers and cradles in the system have different addresses.

CHARGING THE BATTERIES

To charge the battery, simply insert the Gryphon into the base. When the scanner is fully seated in the cradle, it will sound a “chirp” to indicate that the cradle has detected the scanner connection.

The LEDs on the base (shown in Table 1 on page 12) will indicate the status of the battery.



NOTE: The Gryphon GBT/GM4500 may get warm during charging; this is normal and does not mean a malfunction.



NOTE: Before using the battery, read "Battery Safety" on page 47. Datalogic recommends annual replacement of rechargeable battery packs to ensure maximum performance.

THE GBT/GM4500 SCANNER

Scanner LEDs

Specific LEDs on the Gryphon Scanner provide information about: good reading result (3GL), battery status and charging status (with micro USB only). The Battery Status information can be easily retrieved by double-tapping with your fingers on top of the head of the scanner. The following table explains the main colors' combinations provided by the Battery Status LED.

Table 1 - Battery LED

| COLOR | | BATTERY STATUS |
|------------------------------------|---|--------------------------------------|
| Blinking color (1s ON - 1s OFF) | Green (charge = 50% - 99%) Red (charge less than 1%) NOTE: Scanner is unusable until 1% is reached | Charge in Progress through micro USB |
| Solid Green (charge = 100%) | It goes OFF when Scanner is unplugged | Charge Complete through micro USB |
| Solid color (3s time-out) | Green (charge = 50% - 100%) Amber (charge = 2% - 50%) Red blinking (charge less than 2%) | Battery Status |

THE WLC4090 RADIO BASE

Radio Base LEDs

LEDs on the Gryphon Base provide information about the Base as well as battery charging status, as shown in [Figure 12](#).

Figure 12 - Gryphon Base LEDs



Table 2 - Radio Base LEDs

| LED | | STATUS |
|-----|-----------------|--|
| 1 | Power ON / Data | Green On = Base is powered Green Blinking = Base receives data and commands from the Host or the Reader. |
| 2 | Charging | Green On = the battery is completely charged Green fading = battery level 51 to 99% Amber fading = battery level 1 to 50% Red fading = pre-charge |

The button can be used to force device connection via the Datalogic Aladdin Software tool and for paging the scanner when it is activated. Refer to the Gryphon I GD/GM/GBT 4500 Product Reference Guide (PRG) for a more detailed explanation.

USING THE GRYPHON™ I GBT/GM4500

The Gryphon™ I GBT/GM4500 reader normally works by capturing and decoding codes. It is equipped with an internal Motionix™ motion-sensing function which activates the aiming system on device motion. The intelligent aiming system indicates the field of view which should be positioned over the bar code:

Aiming System

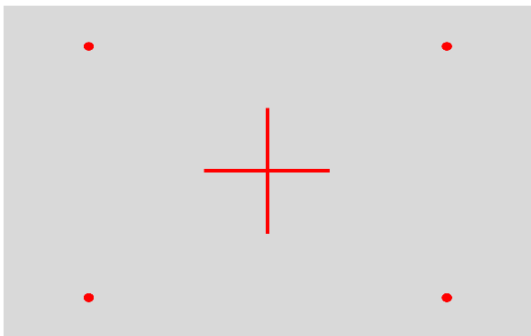

Relative Size and Location of Aiming Pattern

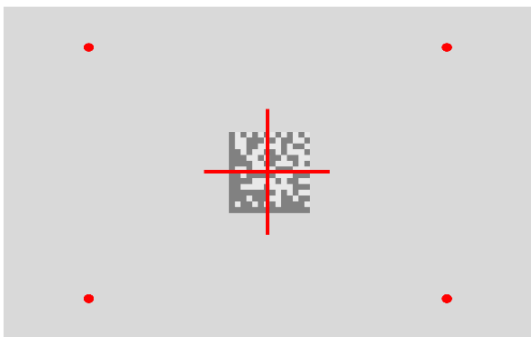

2D Matrix Symbol

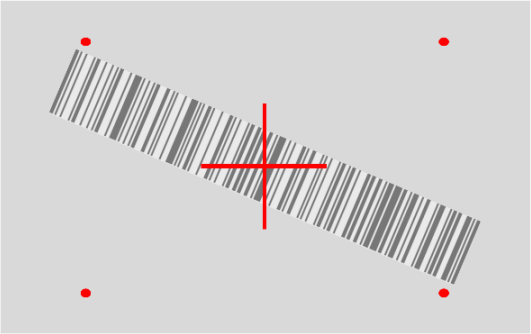

Linear Barcode

A red beam illuminates the label. The field of view indicated by the aiming system will be smaller when the reader is closer to the bar code and larger when it is farther from the code. Symbologies with smaller bars or elements (mil size) should be read closer to the unit. Symbologies with larger bars or elements (mil size) should be read farther from the unit. If the aiming system is centered and the entire bar code is within the aiming field, you will get a good read. Successful reading is signaled by an audible tone plus a good-read green spot LED indicator. Refer to the Gryphon I GD/GM/GBT 4500 Product Reference Guide (PRG) for more information about this feature and other programmable settings.

Relative Size and Location of Green Spot

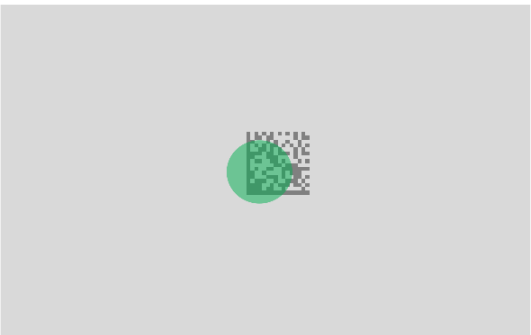

LINKING THE READER

Link Datalogic Devices to Base

Before configuring the interface, it is necessary to link the handheld with the base.

To link the handheld and the base, simply put it into the base. If the reader was previously linked to another base, you must first scan the **Unlink** bar code before re-linking it to the new base.



Unlink

Link Scanner as Serial Device to a Bluetooth Host

Use this procedure to let the scanner communicate with a Bluetooth host using the Bluetooth Serial Port Profile (SPP).

1. If using a Bluetooth adapter on the host device, install any driver provided with the adapter.
2. Scan the **Link to Host in SPP mode** label below to make the scanner visible to the host device.
3. Use the Bluetooth manager of the host device to “Discover new devices” and select "GBT4500...".
If you receive an error message, it may be necessary to change the security settings on either the host device or the scanner.
4. Use an RS-232 terminal program to see incoming data on the port designated by the Bluetooth manager of the host device.



Link to Host in SPP Mode

Link Scanner as HID device to a Bluetooth host

Use this procedure to send data to a Bluetooth host using the Bluetooth HID profile.

1. If using a Bluetooth adapter on the host device, install any driver provided with the adapter.
2. Scan the **Link to Host in HID mode** label below to make the scanner visible to the host device.
3. Use the Bluetooth manager of the host device to "Discover new devices" and select "GBT4500 ...". If you receive an error message, it may be necessary to change the security settings on either the host device or the scanner.
4. On the host device, open the program that is meant to receive the incoming data.

The data transmitted by the scanner will appear in the program as if it was typed using the keyboard of the host device.



Link to Host in HID mode



NOTE: The Gryphon I GBT4500 can be set up to authenticate the remote system when connecting, by entering a Bluetooth passkey or a PIN code. If you want to set the security level and authentication options suitable for your application, or when adding new equipment to a system that requires authentication or uses a custom security PIN, please see the PRG for information.

POWER OFF

Scan the bar code below to shut off power to the hand-held until the next trigger pull.



Power Off

SELECTING THE INTERFACE TYPE

Upon completing the physical connection between the reader and its host, proceed directly to Interface Selection below for information and programming for the interface type supported by the reader and scan the appropriate bar code to select your system's correct interface type, according to your application.

For interfaces other than those listed in this manual, see the Gryphon I GD/GM/GBT 4500 Product Reference Guide (PRG), available online at www.datalogic.com.

Interface Selection

The reader will support all the following host interfaces:

- RS-232 STD
- RS-232 WN
- IBM46XX port 9b (a specific cable is required)
- USB HID POS
- USB Toshiba TEC
- USB (Keyboard, COM, OEM)
- USB Composite (Keyboard + COM)
- Keyboard Wedge

Information and programming options for each interface type are provided in this section. For defaults and additional information associated with each interface, proceed to the corresponding chapter in the Gryphon™ I GD/GBT/GM4500 PRG.





CONFIGURING THE INTERFACE

Scan the appropriate programming bar code to select the interface type for your system.



NOTE: Unlike some other programming features and options, interface selections require that you scan only one programming bar code label. **DO NOT** scan an ENTER/EXIT bar code prior to scanning an interface selection bar code.

Some interfaces require the scanner to start in the disabled state when powered up. If additional scanner configuration is desired while in this state, pull the trigger and hold for 5 seconds. The scanner will change to a state that allows programming with bar codes.

| RS-232 |
|---|
|  Select RS232-STD RS-232 standard interface |
|  Select RS232-WN RS-232 Wincor-Nixdorf |
|  Select RS-232 OPOS RS-232 for use with OPOS/UPOS/JavaPOS |
|  Select USB-COM-STD ^a USB Com to simulate RS-232 standard interface |

a. Download the correct USB Com driver from www.datalogic.com

USB-OEM



Select USB-OEM
USB-OEM (can be used for OPOS/UPOS/JavaPOS)

USB-COMPOSITE



Select USB-Composite
USB-Composite (Keyboard + COM)

IBM46XX



Select IBM46xx Port 9b

ADDITIONAL INTERFACES



Select USB HID POS



Select USB Toshiba TEC

Keyboard Interface

Use the programming bar codes to select options for USB-Keyboard and Wedge Interfaces.

KEYBOARD



Select KBD-AT
(AT, PS/2 25-286, 30-286, 50, 50Z, 60, 70, 80, 90 & 95
w/standard key encoding)



Select KBD-AT-NK
(IBM AT PS2 with standard key encoding
but without external keyboard.)



Select KBD-AT-ALT
(AT, PS/2 25-286, 30-286, 50, 50Z, 60, 70, 80, 90 & 95
w/Alternate Key)



Select KBD-AT-ALT-NK
(Keyboard Wedge for IBM AT PS2 with alternate key encoding
but without external keyboard)

KEYBOARD (CONTINUED)



★ Select USB Keyboard
(USB Keyboard with standard key encoding)



Select USB Alternate Keyboard
(USB Keyboard with alternate key encoding)

★ = default value

Scancode Tables

Refer to Gryphon I GD/GBT/GM4500 PRG for information about control character emulation for keyboard interfaces.

Country Mode

This feature specifies the country/language supported by the keyboard. Only the following interfaces support ALL Country Modes.

- USB Keyboard with alternate key encoding
- USB Keyboard with standard key encoding
- AT, PS/2 25-286, 30-286, 50, 50Z, 60, 70, 80, 90 & 95 w/Std Key Encoding
- Keyboard Wedge for IBM AT PS2 with standard key encoding but without external keyboard
- AT, PS/2 25-286, 30-286, 50, 50Z, 60, 70, 80, 90 & 95 without Alternate Key
- Keyboard Wedge for IBM AT PS2 without alternate key encoding but without external keyboard

All other interfaces support ONLY the following Country Modes: U.S., Belgium, United Kingdom, France, Germany, Italy, Spain, Sweden.

COUNTRY MODE**ENTER/EXIT PROGRAMMING MODE**

★ Country Mode = U.S.



Country Mode = Belgium



Country Mode = Croatia*



Country Mode = Czech Republic*



Country Mode = Denmark*



Country Mode = France

COUNTRY MODE (CONTINUED)



Country Mode = French Canadian



Country Mode = Germany



Country Mode = Hungary*



Country Mode = Italy



Country Mode = Japanese 106-key*



Country Mode = Lithuanian



Country Mode = Norway*

COUNTRY MODE (CONTINUED)

Country Mode = Poland*



Country Mode = Portugal*



Country Mode = Romania*



Country Mode = Slovakia



Country Mode = Spain



Country Mode = Sweden



Country Mode = Switzerland*

COUNTRY MODE (CONTINUED)

Country Mode = United Kingdom

★ = default value

* Supports only the interfaces listed in the Country Mode feature description.

PROGRAMMING

The reader is factory-configured with a set of standard default features. After scanning the interface bar code from the Interfaces section, select other options and customize your reader through use of the programming bar codes available in the Gryphon™ I GD/GBT/GM4500 PRG. Check the corresponding features section for your interface, and also the Data Editing and Symbologies chapters of the PRG.

Using Programming Bar Codes

This manual contains bar codes which allow you to reconfigure your reader. Some programming bar code labels, like the "Reset Default Settings" on [page 27](#), require only the scan of that single label to enact the change.

Other bar codes require the reader to be placed in Programming Mode prior to scanning them. Scan an ENTER/EXIT bar code once to enter Programming Mode; scan the desired parameter settings; scan the ENTER/EXIT bar code again to accept your changes, which exits Programming Mode and returns the reader to normal operation.

Configure Other Settings

Additional programming bar codes are available in the PRG to allow customization of programming features. If your installation requires different programming than the standard factory default settings, refer to the PRG.

Resetting Product Defaults

If you are not sure what programming options have been set in your reader, or you have changed some options and want your custom factory settings restored, scan the bar code below to reset the reader to its initial configuration. Refer to

the PRG for other options, and a listing of standard factory settings.





NOTE: Factory defaults are based on the interface type. Be sure your reader is configured for the correct interface before scanning this label. See "Selecting the Interface Type" on page 18 for more information.



Reset Default Settings

NUMLOCK





This option specifies the setting of the Numbers Lock (Numlock) key while in keyboard wedge interface. This only applies to alternate key encoding interfaces. It does not apply to USB keyboard.

| NUMLOCK |
|--|
|  <p>ENTER/EXIT PROGRAMMING MODE</p> |
|  <p>★ Numlock = Numlock key unchanged</p> |
|  <p>Numlock = Numlock key toggled</p> |

★ = default value

CAPS LOCK STATE

This option specifies the format in which the reader sends character data. This applies to keyboard wedge interfaces. This does not apply when an alternate key encoding keyboard is selected.

| CAPS LOCK STATE |
|--|
|  ENTER/EXIT PROGRAMMING MODE |
|  ★ Caps Lock OFF |
|  Caps Lock ON |
|  AUTO Caps Lock Enable |

★ = default value

READING PARAMETERS

Move the reader toward the target and center the aiming pattern and illumination system to capture and decode the image. See "[Using the Gryphon™ I GBT/GM4500](#)" on [page 14](#) for more information.

The aiming system will briefly switch off after the acquisition time, and if no code is decoded will switch on again before the next acquisition. The illuminator will remain on until the symbol is decoded.



As you read code symbols, adjust the distance at which you are holding the reader.

Aiming System

A number of options for customizing control of the Aiming System are available. See the Gryphon™ I GD/GBT/GM4500 PRG for more information and programming bar codes.

Good Read Green Spot Duration

Successful reading can be signaled by a good read green spot. Use the bar codes that follow to specify the duration of the good read pointer beam after a good read.

| GOOD READ GREEN SPOT DURATION |
|---|
| <div data-bbox="467 1278 578 1389" style="text-align: center;">  </div> <div data-bbox="277 1411 767 1444" style="text-align: center;"> <p>ENTER/EXIT PROGRAMMING MODE</p> </div> |
| <div data-bbox="451 1495 593 1639" style="text-align: center;">  </div> <div data-bbox="470 1645 573 1678" style="text-align: center;"> <p>Disable</p> </div> |
| <div data-bbox="451 1731 593 1875" style="text-align: center;">  </div> <div data-bbox="405 1882 643 1915" style="text-align: center;"> <p>★ Short (300 ms)</p> </div> |

GREEN SPOT DURATION (CONTINUED)



Medium (500 ms)



Long (800 ms)

★ = default value

OPERATING MODES

Scan Mode

The reader can be set to operate in one of several scanning modes. See the PRG for more information and settings for any of the following options:

Trigger Single (Default) This mode is associated with the typical handheld reader operation. When the trigger is pulled, illumination is turned on and the scanner attempts to read a label.

Scanning is activated until one of the following occurs:

- the programmable Scanning Active Time¹ expires
- a label has been read
- the trigger is released

Trigger Hold Multiple - When the trigger is pulled, scanning starts and the product scans until the trigger is released or Scanning Active Time¹ expires. Reading a label does not disable scanning. Double Read Timeout¹ prevents undesired multiple reads while in this mode.

Trigger Pulse Multiple - Scanning begins when the trigger is pulled and continues after the trigger is released, until the trigger is pulled again or until the programmable Scanning Active Time¹ expires. Reading a label does not disable





1. See the Product Reference Guide (PRG) for these and other programmable features.

scanning. Double Read Timeout¹ prevents undesired multiple reads while in this mode.

Flashing - The reader illuminator flashes on and off regardless of the trigger status. Code reading takes place only during the Flash On Time¹. Double Read Timeout¹ prevents undesired multiple reads.

Always On - The illuminator is always ON and the reader is always ready for code reading. Double Read Timeout¹ prevents undesired multiple reads.

Object Detection - The scanner looks for changes within its field-of-view. The Aiming Pattern is always on to show the optimum reading area. If a predefined amount of movement is detected, the red illumination switches on. Scanning continues until a label is read or Scanning Active Time¹ expires.

| SCAN MODE |
|---|
|  <p>ENTER/EXIT PROGRAMMING MODE</p> |
|  <p>★ Trigger Single</p> |
|  <p>Trigger Hold Multiple</p> |
|  <p>Trigger Pulse Multiple</p> |

1. See the Product Reference Guide (PRG) for these and other programmable features.

SCAN MODE (CONTINUED)



Scan Mode Flashing^a



Scan Mode Always ON



Object Detection

- a. Controlled by Flash On Time and Flash Off Time. See the PRG to program these parameters.



★ = default value

PICK MODE

This option specifies the ability of the reader to decode labels only when they are close to the center of the aiming pattern, which is the area indicated by the red cross. Pick Mode is a Decoding and Transmission process where bar codes that are not within the configurable distance from the center of the aiming pattern are not acknowledged or transmitted to the host. It is active only while the scanner is in Trigger Single mode. If the scanner switches to a different Read Mode, Pick Mode is automatically disabled.



NOTE: This feature is not compatible with Multiple Labels Reading in a Volume. See the PRG for more information.

| PICK MODE |
|---|
|  ENTER/EXIT PROGRAMMING MODE |
|  ★ Pick Mode = Disable |
|  Pick Mode = Enable |

★ = default value

MULTIPLE LABEL READING

The reader offers a number of options for multiple label reading. See the PRG or software configuration tool for descriptions of these features and programming labels.

TECHNICAL SPECIFICATIONS

The following table contains Physical and Performance Characteristics, User Environment and Regulatory information.

| PHYSICAL CHARACTERISTICS | |
|----------------------------|---|
| Color | Black White |
| Dimensions | Gun only (LHD): 68.4 x 165.8 x 110.0mm (2.7" x 6.5" x 4.3") Cradle only (LHD): 94.6 x 128.7 x 212.7mm (3.7" x 5.1" x 8.4") Gun on Cradle Horizontal mount (LHD): 94.6 x 134.0 x 212.7mm (3.7" x 5.3" x 8.4") Gun on Cradle Presentation mount (LHD): 94.6 x 170.7 x 183.6mm (3.7" x 6.7" x 7.2") |
| Weight | Approx. 235 g (8.29 oz.) GBT4500 or GM4500 and battery pack included Battery Pack is approx. 65 g (2.29 oz.) |
| ELECTRICAL CHARACTERISTICS | |
| Power Supply (WLC4190) | 5V to 14V +/-5% in the Communication Port 5V to 14V +/-5% in the Aux Power Port NOTE: Aux Power Port is recommended when long cables are connected to Communication Port |
| Consumption (Typical) | Gun Only: 330 mA @ 3.7V(Operative) Cradle Only: 80 mA @ 5V (Operative) Cradle with Gun in Charge (Scan while Charging): 475 mA (PC host USB) 1150 mA (5V on Aux Power Port) 520 mA (12V on Aux Power Port) Gun Charging via micro USB: 480 mA (PC host port, no Scan) 900 mA (wall adapter, no Scan) 1160 mA (wall adapter, Scan while Charging) |
| Battery Capacity | Li-Ion 3.6V, 3250 mAh (11.7Wh) |
| Recharge Time (Typical) | Values valid for a fully depleted battery USB Only: 11h (no Scan) 15h (Scan while Charging) Using Aux Power Port: 3h (no Scan) 3.5h (Scan while Charging) Using micro USB (wall adapter): 2h (no Scan, with Wall Adapter) 4.6h (no Scan, with PC Host) |
| Max. Scan Rate | 50 frames/sec |
| Reading Indicators | Top and rear illumination, Good Read Spot, Beep, Vibrator |

| ENVIRONMENTAL CHARACTERISTICS | |
|-------------------------------|--|
| Operating Temperature | 0 °C to + 50 °C (+32° F to +122 °F) |
| Storage Temperature | -40 °C to + 70 °C (-40 ° F to +158 °F) |
| Humidity | 95% non condensing |
| Drop Resistance | IEC 68-2-32 Tested 1.8 m (6 ft) |
| ESD Protection | 16 KV |
| Protection Class | IP52 |
| Cable Length | Refer to www.datalogic.com |
| OPTICAL CHARACTERISTICS | |
| Optical Format | 1/4" |
| Active Imager Size | 3896 um (H) x 2453 um (V) |
| Active Pixels | 1280 H x 800 V |
| Illumination System | LED source Warm White Emission (wavelength = 350 - 770 nm) Hyper Red Emission (wavelength = 660 nm, DGM model only) IEC 62471 Exempt Risk Group |
| Aiming System | RED laser source IEC 60825-1 Class 2 Radiation 1 mW Avg., Emitted wavelength 650 nm, 10ms pulse |
| Ambient Light | Up to 100,000 lux |
| Tilt Tolerance ^a | 0° - 360° |
| Pitch Tolerance ^a | ± 65° |
| Skew Tolerance ^a | ± 65° |
| Field of View ^a | 36° H x 23° V |
| PCS (Datalogic Test Chart) | minimum 15% |

a. Based on ISO 15423 specifications.

| READING CHARACTERISTICS | | |
|-------------------------|--|---|
| | SR | HD |
| DOF ^a | Code 39 5 mil: 7.0 - 38.0 cm (2.7" - 14.9") 10 mil: 2.2 - 58.0 cm (0.8" - 22.8") 20 mil: FOV lim. - 110 cm (up to 43.3") | Code 39 3 mil: 5.0 - 15.0 cm (2.0" - 5.9") 5 mil: 0.5 - 25.0 cm (0.2" - 9.8") 10 mil: 0.5 - 45.0 cm (0.2" - 17.7") |
| | EAN13 7.5 mil: 9.0 - 30.0 cm (3.5" - 11.8") 13 mil: 1.0 - 71.0 cm (0.4" - 27.9") | EAN13 7.5 mil: 2.0 - 23.5 cm (0.8" - 9.2") 13 mil: 1.0 - 40.0 cm (0.4" - 15.7") |
| | PDF417 6.6 mil: 6.5 - 24.0 cm (2.6" - 9.4") 10 mil: 2.5 - 41.0 cm (1.0" - 16.1") 15 mil: 2.3 - 65.0 cm (0.9" - 25.6") | PDF417 4 mil: 3.0 - 12.0 cm (1.2" - 4.7") 6.6 mil: 0.5 - 23.5 cm (0.2" - 9.2") 10 mil: 0.5 - 31.0 cm (0.2" - 12.2") |
| | Data Matrix 10 mil: 5.5- 27.0 cm (2.2" - 10.6") 15 mil: 2.8 - 41.0 cm (1.1" - 16.1") | Data Matrix 5 mil: 5.5 - 9.0 cm (2.2" - 3.5") 10 mil: 0.2 - 27.0 cm (0.1" - 10.6") |
| | Resolution (Maximum) 1D Min = 4 mils PDF417 Min = 5 mils Data Matrix Min = 7.5 mils | 1D Min = 3 mils PDF417 Min = 3 mils Data Matrix Min = 4 mils |

a. All labels grade A, typical environmental light, 20°C, label inclination 10°.

| DECODE CAPABILITY |
|---|
| <p>1D Bar Codes</p> <p>UPC/EAN/JAN (A, E, 13, 8); UPC/EAN/JAN (including P2 /P5); UPC/EAN/JAN (including; ISBN / Bookland & ISSN); UPC/EAN Coupons; Code 39 (including full ASCII); Code 39 Trioptic; Code39 CIP (French Pharmaceutical); LOGMARS (Code 39 w/ standard check digit enabled); Danish PPT; Code 32 (Italian Pharmacode 39); Code 128; Code 128 ISBT; Interleaved 2 of 5; Standard 2 of 5; Interleaved 2 of 5 CIP (HR); Industrial 2 of 5; Discrete 2 of 5; Matrix 2 of 5; IATA 2of5 Air cargo code; Code 11; Codabar; Codabar (NW7); ABC Codabar; EAN 128; Code 93 ; MSI; PZN; Plessey; Anker Plessey; GS1 DataBar Omnidirectional; GS1 DataBar Limited; GS1 DataBar Expanded; GS1 DataBar Truncated; DATABAR Expanded Coupon.</p> |
| <p>2D / Stacked Codes</p> <p>The Gryphon I GBT/GM4500 scanner is capable of decoding the following symbologies using multiple frames (i.e. Multi-Frame Decoding): Data Matrix; Inverse Data Matrix; Data Matrix is configurable for the following parameters:; Normal or Inverted; Square or Rectangular Style; Data length (1 - 3600 characters); Maxicode; QR Codes (QR, Micro QR and Multiple QR Codes); Aztec; Postal Codes - (Australian Post; Japanese Post; KIX Post; Planet Code; Postnet; Royal Mail Code (RM45CC); Intelligent Mail Barcode (IMB); Sweden Post; Portugal Post); LaPoste A/R 39; PDF-417; MacroPDF; Micro PDF417; GS1 Composites (1 - 12); French CIP13^a; GS1 DataBar Stacked; GS1 DataBar Stacked Omnidirectional; GS1 DataBar Expanded Stacked; GS1 Databar Composites; Chinese Sensible Code; Inverted 2D codes^b.</p> |

- a. It is acceptable to handle this with ULE
- b. The SW can apply the Normal/Reverse Decoding Control to the following symbologies: Data Matrix, QR, Micro QR, Aztec and Chinese Sensible Code.

| REGULATORY | | | |
|--|---------------|---------------|-----------|
| See Regulatory Addendum | | | |
| RADIO CHARACTERISTICS | | | |
| Wireless Technology | Star™ 910 MHz | Star™ 433 MHz | Bluetooth |
| Range (in open air) | 50 m | 50 m | 100 m |
| Max number of devices per base station | 16 | | 7 |

LED AND BEEPER INDICATIONS

The imager's beeper sounds and its illumination flashes or changes color to indicate various functions or errors on the reader. A "Green Spot" also lights to indicate a good read. The tables below list these indications. Reference the PRG for a more detailed list.

| INDICATION | LED | BEEPER |
|-----------------------------|--|---|
| Power-up | Upper LED flashes/blinks on power-up, however, this may be too rapid to view. With a USB interface, the LED blinks until enumeration with the host is completed. | Imager beeps four times at highest frequency and volume upon power-up. |
| Good Read | Upper green LED comes on for programmed time (default). LED behavior for this indication is configurable using Aladdin utility. | One beep at current frequency, volume, mono/bi-tonal setting upon a successful label scan. It is also possible to upload custom jingles with Aladdin. |
| ROM Failure | 200ms on / 200ms off | Imager sounds one error beep at highest volume for 200 mS. |
| Limited Scanning Label Read | N/A | Imager 'chirps' six times at the highest frequency and current volume. |
| Imager Disabled | The LED blinks continuously 100mS on / 900 mS off | N/A |

TROUBLESHOOTING

| PROBLEM | POSSIBLE CAUSE | POSSIBLE SOLUTION |
|--|--|--|
| Nothing happens when the scan button is pulled. | No power to the imager. | Check system power. Ensure power supply is connected. |
| | Interface or power cables are loose. | Ensure all cable connections are secure. |
| LED comes on, but bar code is not decoded. | Imager not programmed for correct bar code type. | Ensure reader is programmed to read the type of bar code scanned. Refer to the PRG for more information. |
| | Bar code label is unreadable. | Check the label to ensure it is not defaced. Try to scan another bar code type. |
| | Distance between reader and bar code is incorrect. | Move imager closer to or further from the bar code. |
| Bar code is decoded but not transmitted to the host. | Imager not programmed for the correct host type. | Scan the appropriate host type bar code. Refer to the PRG for more information. |



NOTE: For detailed troubleshooting, refer to the **PRG (Product Reference Guide)**.

WARRANTY

Datalogic warrants that the Products shall be free from defects in materials and workmanship under normal and proper use during the Warranty Period. Products are sold on the basis of specifications applicable at the time of manufacture and Datalogic has no obligation to modify or update Products once sold. The Warranty Period shall be **three years** from the date of shipment by Datalogic, unless otherwise agreed in an applicable writing by Datalogic.

Datalogic will not be liable under the warranty if the Product has been exposed or subjected to any: (1) maintenance, repair, installation, handling, packaging, transportation, storage, operation or use that is improper or otherwise not in compliance with Datalogic's instruction; (2) Product alteration, modification or repair by anyone other than Datalogic or those specifically authorized by Datalogic; (3) accident, contamination, foreign object damage, abuse, neglect or negligence after shipment to Buyer; (4) damage caused by failure of a Datalogic-supplied product not under warranty or by any hardware or software not supplied by Datalogic; (5) any device on which the warranty void seal has been altered, tampered with, or is missing; (6) any defect or damage caused by natural or man-made disaster such as but not limited to fire, water damage, floods, other natural disasters, vandalism or abusive events that would cause internal and external component damage or destruction of the whole unit, consumable items; (7) use of counterfeit or replacement parts that are neither manufactured nor approved by Datalogic for use in Datalogic-manufactured Products; (8) any damage or malfunctioning caused by non-restoring action as for example firmware or software upgrades, software or hardware reconfigurations etc.; (9) loss of data; (10) any consumable or equivalent (e.g. cables, power supply, batteries, etc.); or (11) any device on which the serial number is missing or not recognizable.

THE DATALOGIC WARRANTIES ARE EXCLUSIVE AND IN LIEU OF ALL OTHER WARRANTIES, WHETHER WRITTEN, EXPRESS, IMPLIED, STATUTORY OR OTHERWISE, INCLUDING, BUT NOT LIMITED TO, THE IMPLIED WARRANTIES OF MERCHANTABILITY AND FITNESS FOR PARTICULAR PURPOSE. DATALOGIC SHALL NOT BE LIABLE FOR ANY DAMAGES SUSTAINED BY BUYER ARISING FROM DELAYS IN THE REPLACEMENT OR REPAIR OF PRODUCTS UNDER THE ABOVE. THE REMEDY SET FORTH IN THE WARRANTY STATEMENT IS THE BUYER'S SOLE AND EXCLUSIVE REMEDY FOR WARRANTY CLAIMS. NO EXTENSION OF THIS WARRANTY WILL BE BINDING UPON DATALOGIC UNLESS SET FORTH IN WRITING AND SIGNED BY DATALOGIC'S AUTHORIZED REPRESENTATIVE. DATALOGIC'S LIABILITY FOR DAMAGES ON ACCOUNT OF A CLAIMED DEFECT IN ANY PRODUCT DELIVERED BY DATALOGIC SHALL IN NO EVENT EXCEED THE PURCHASE PRICE OF THE PRODUCT ON WHICH THE CLAIM IS BASED. DATALOGIC SHALL NOT BE LIABLE FOR DAMAGES RELATING TO ANY INSTRUMENT, EQUIPMENT, OR APPARATUS WITH WHICH THE PRODUCT SOLD UNDER THIS AGREEMENT IS USED. Further details on warranty coverage, rights and conditions are addressed under and regulated by the Terms and Conditions of Sales of Datalogic available at https://www.datalogic.com/terms_conditions_sales.

ERGONOMIC RECOMMENDATIONS



CAUTION: In order to avoid or minimize the potential risk of ergonomic injury, follow the recommendations below. Consult with your local Health & Safety Manager to ensure that you are adhering to your company's safety programs to prevent employee injury.

- Reduce or eliminate repetitive motion
- Maintain a natural position
- Reduce or eliminate excessive force
- Keep objects that are used frequently within easy reach
- Perform tasks at correct heights
- Reduce or eliminate vibration
- Reduce or eliminate direct pressure
- Provide adjustable workstations
- Provide adequate clearance
- Provide a suitable working environment
- Improve work procedures.

TECHNICAL SUPPORT

Support Through the Website

Datalogic provides several services as well as technical support through its website. Log on to (www.datalogic.com).

For quick access, from the home page click on the search icon , and type in the name of the product you're looking for. This allows you access to download Data Sheets, Manuals, Software & Utilities, and Drawings.

Hover over the Support & Service menu for access to Services and Technical Support.

Reseller Technical Support

An excellent source for technical assistance and information is an authorized Datalogic reseller. A reseller is acquainted with specific types of businesses, application

software, and computer systems and can provide individualized assistance.

CLEANING PROCEDURE

Proper cleaning is needed on the external plastic surfaces, output window and electrical contacts to guarantee reliable scanning and charging of the battery.

A regular cleaning routine will remove the dust and dirt that may accumulate on the product over time. The maintenance activity may be repeated more frequently depending on the severity of the environment in which the scanner is used.

A periodic deeper cleaning is suggested once per month.

Cleaning plastic surfaces

Exterior surfaces and scan windows exposed to spills, smudges or debris accumulation require periodic cleaning to ensure best performance during scanning operations. Follow the procedures described in this instruction sheet to keep your Gryphon device in good operating condition.



WARNING: Be sure to turn off power and unplug the device from electrical outlet before cleaning.



CAUTION: DO NOT use abrasive pads or cleaning agents.

Common Cleaning Solutions

The cleaners and disinfectants listed below are recommended for use on Datalogic Disinfectant-Ready Enclosures:

| PRODUCT | CHEMICAL CONTENT |
|---|--|
| Sani-Cloth® HB, Sani-Cloth® Plus, Super Sani-Cloth® | Quaternary Ammonium Chloride solution |
| Hepacide Quat II | Virucidal disinfectant cleaner |
| Alcohol Wipes | 70% Isopropyl Alcohol |
| CaviWipes™ | Isopropanol 10-20%; Ethylene Glycol Monobutyl Ether 1-5% |

| PRODUCT | CHEMICAL CONTENT |
|---|---|
| Virex® 256 | n-Alkyl Dimethyl Benzyl Ammonium Chloride; Didecyl Dimethyl Ammonium Chloride |
| Formula 409® Glass and Surface Cleaner | n-Alkyl Dimethyl Benzyl Ammonium Chloride; n-Propoxypropanol |
| Windex® Blue | Isopropyl Alcohol |
| Clorox® Bleach; Clorox Healthcare Bleach Germicidal Cleaner | Sodium Hypochlorite; Sodium Hydroxide |
| Hydrogen Peroxide | 3% |
| ProSpray™ Wipes (Disinfectant towelettes) | 0.647% o-phenylphenol; 0.070% o-benzyl-p-chlorophenol |
| 100% Gentle dish soap and water | |



NOTE: Disinfectants may be harsh on metal. They are recommended for use only on enclosures.



**CAUTION: DO NOT spray or pour cleaner directly onto the unit.
DO NOT use solutions in their concentrated form.
DO NOT use aerosols, solvents or abrasives.
DO NOT use paper towels or rough cloths to clean windows.**

Cleaning enclosure and window surfaces

1. Moisten a soft cloth with a recommended cleaning solution. Be sure to apply the solution to your cloth first. Wring excessive liquid from the cloth.
2. Use the cloth to wipe down the surface of the unit. Use cotton swabs, lightly moistened, to reach in corners and crevices.
3. Use another clean dry cloth to remove any residue of the cleaning agent and ensure the unit is dry.



REPLACING THE BATTERY PACK



NOTE: Before proceeding, read "Battery Safety" on page 47. Datalogic recommends annual replacement of rechargeable battery packs to ensure maximum performance.

Use the following procedure to change the reader's battery:

1. With a narrow metallic object (i.e. a coin) or a screwdriver, unscrew the battery cover screw.



2. Extract the battery pack from its slot.



3. Insert the new battery in the same position.



4. Replace the battery holder cap, plug in the connector and return the contacts circuit to its previous location.



NOTE: When inserting the new battery into the handle, take care to position the battery and the connector as described above.

5. Insert the cover in the handle and screw it into place.



BATTERY SAFETY

To install, charge and/or perform any other action on the battery, follow the instructions in this manual.



WARNING: Do not discharge the battery using any device except for the scanner. When the battery is used in devices other than the designated product, it may damage the battery or reduce its life expectancy. If the device causes an abnormal current to flow, it may cause the battery to become hot, explode or ignite and cause serious injury. Lithium-ion battery packs may get hot, explode or ignite and cause serious injury if exposed to abusive conditions. Be sure to follow the safety warnings listed on the following page.



WARNING:

- Do not place the battery pack in fire or heat.
- Do not connect the positive terminal and negative terminal of the battery pack to each other with any metal object (such as wire).
- Do not carry or store the battery pack together with metal objects.
- Do not pierce the battery pack with nails, strike it with a hammer, step on it or otherwise subject it to strong impacts or shocks.
- Do not solder directly onto the battery pack.
- Do not expose the battery pack to liquids, or allow the battery to get wet.
- Do not apply voltages to the battery pack contacts.



WARNING: In the event the battery pack leaks and the fluid gets into your eye, do not rub the eye. Rinse well with water and immediately seek medical care. If left untreated, the battery fluid could cause damage to the eye.



WARNING: Fire or explosion hazard if battery is replaced with an incorrect model.



CAUTION: Always charge the battery at 32° – 104°F (0° – 40°C) temperature range. Use only the authorized power supplies, battery pack, chargers, and docks supplied by your DataLogic reseller. The use of any other power supplies can damage the device and void your warranty. Do not disassemble or modify the battery. The battery contains safety and protection devices, which, if damaged, may cause the battery to generate heat, explode or ignite.



CAUTION: DO NOT place the battery in or near fire, on stoves or other high temperature locations. DO NOT place the battery in direct sunlight, or use or store the battery inside cars in hot weather. Doing so may cause the battery to generate heat, explode or ignite. Using the battery in this manner may also result in a loss of performance and a shortened life expectancy.



CAUTION: DO NOT place the battery in microwave ovens, high-pressure containers or on induction cookware. Immediately discontinue use of the battery if, while using, charging or storing the battery, the battery emits an unusual smell, feels hot, changes color or shape, or appears abnormal in any other way. DO NOT replace the battery pack when the device is turned on. DO NOT remove or damage the battery pack's label. DO NOT use the battery pack if it is damaged in any part. Battery pack usage by children should be supervised.

As with other battery types, Lithium-Ion (LI) batteries will lose capacity over time. Capacity deterioration is noticeable after one year of service whether the battery is in use or not. It is difficult to precisely predict the finite life of a LI battery, but cell manufacturers rate them at 500 charge cycles. In other words, the batteries should be expected to take 500 full discharge/charge cycles before needing replacement. This number is higher if partial discharging/recharging is adhered to rather than full/deep discharging.



CAUTION: Storage of batteries for long time at fully charged status or at fully discharged status should be avoided.



CAUTION: Only in case of long storage, to avoid deep discharge of the battery it is recommended to partially recharge the battery every three months to keep the charge status at a medium level.

As a reference, run a fast recharge for 20 minutes every three months on unused products to avoid any performance deterioration of the cell.

The useful life of LI batteries depends on usage and number of charges, etc., after which they should be removed from service, especially in mission critical applications. Do not continue to use a battery showing excessive loss of capacity, it should be properly recycled / disposed of and replaced.

Collect and recycle waste batteries separately from the device to comply with European Directive 2006/66/EC, 2011/65/EU, 2002/96/EC and 2012/19/EU and subsequent modifications, US and China regulatory and other laws and regulations about the environment.

©2011-2021 Datalogic S.p.A. and /or its affiliates. • All rights reserved • Without limiting the rights under copyright, no part of this documentation may be reproduced, stored in or introduced into a retrieval system, or transmitted in any form or by any means, or for any purpose, without the express written permission of Datalogic S.p.A. and/or its affiliates • Datalogic and the Datalogic logo are registered trademarks of Datalogic S.p.A. in many countries, including the U.S. and the E.U.



Datalogic S.r.l.

Via S. Vitalino, 13 | 40012 Calderara di Reno | Bologna - Italy
Tel. +39 051 3147011 | Fax +39 051 3147205



820121600

Rev B

June 2021