

# MAGELLAN™ 3450VSi

## PRODUCT REFERENCE GUIDE



Omni-Directional Imaging Scanner

 **DATALOGIC**

**Datalogic S.r.l.**

Via S. Vitalino, 13  
40012 Calderara di Reno — Italy  
Tel. +39 051 3147011  
Fax +39 051 3147205

**© 2016-2022 Datalogic S.p.A. and /or its affiliates**

All rights reserved. Without limiting the rights under copyright, no part of this documentation may be reproduced, stored in or introduced into a retrieval system, or transmitted in any form or by any means, or for any purpose, without the express written permission of Datalogic S.p.A. and/or its affiliates.

Owners of Datalogic products are hereby granted a non-exclusive, revocable license to reproduce and transmit this documentation for the purchaser's own internal business purposes. Purchaser shall not remove or alter any proprietary notices, including copyright notices, contained in this documentation and shall ensure that all notices appear on any reproductions of the documentation.

Electronic versions of this document may be downloaded from the Datalogic website ([www.datalogic.com](http://www.datalogic.com)). If you visit our website and would like to make comments or suggestions about this or other Datalogic publications, please let us know via the "Contact" page.

**Disclaimer**

Datalogic has taken reasonable measures to provide information in this manual that is complete and accurate, however, Datalogic shall not be liable for technical or editorial errors or omissions contained herein, nor for incidental or consequential damages resulting from the use of this material. Datalogic reserves the right to change any specification at any time without prior notice.

**Trademarks**

Datalogic and the Datalogic logo are registered trademarks of Datalogic S.p.A. in many countries, including the U.S.A. and the E.U.

Magellan is a trademark of Datalogic S.p.A. or of Datalogic and/or its affiliates, registered in many countries, including the U.S. and the E.U.

**Patents**

See [www.patents.datalogic.com](http://www.patents.datalogic.com) for patent list.

**The content of this manual refers to software version DR9401391.**

# TABLE OF CONTENTS

---

<b>CHAPTER 1. GETTING STARTED.....</b>	<b>1</b>
<b>About This Manual .....</b>	<b>1</b>
Manual Conventions .....	1
<b>Connecting the Scanner .....</b>	<b>2</b>
<b>Mount Installation .....</b>	<b>5</b>
Wall Mount .....	5
Countertop Mount .....	6
Adjustable Riser .....	6
<b>CHAPTER 2. PROGRAMMING .....</b>	<b>7</b>
<b>Introduction to Label Programming .....</b>	<b>7</b>
<b>Understanding the Basics .....</b>	<b>7</b>
Using the Programming Bar Codes .....	7
Resetting the Standard Product Defaults .....	7
Using a Bar Code Mask .....	8
Going Green .....	8
<b>Bar Code Mask .....</b>	<b>9</b>
SCANNING FEATURES .....	11
1D Double Read Timeout .....	11
2D Double Read Timeout .....	12
DIGITAL WATERMARK (DIGIMARC®) FEATURES .....	13
Digital Watermark (Digimarc) Enable .....	13
Digital Watermark (Digimarc) Double Read Timeout .....	14
Digital Watermark (Digimarc) Data Format .....	15
Sleep Mode Timer .....	16
1D Inverse Read Control .....	16
2D Inverse Read Control .....	17
READING ILLUMINATION DURATION .....	18
LED AND BEEPER INDICATORS .....	19
Power On Alert .....	19
Illumination During Disable Mode .....	20
Object Sense Control .....	21
Exposure Control .....	22
External Read Indicator (ERI) .....	23
ERI Timeout .....	23
Good Read LED Idle State .....	24
Scanner Control Button Options .....	25
Good Read Beep Control .....	26
Good Read Beep Frequency .....	27
Good Read Beep Length .....	28
Good Read Beep Volume .....	29
Good Read When to Indicate .....	30
Host Download to Handheld .....	31
Handheld Host Download Timeout .....	31
IMAGING FEATURES .....	33
Image Capture to the Host by Host Command .....	33
Image Capture to the Host by Camera Button .....	34

Camera Button Mode .....	34
Image Destination .....	35
Cell Phone Mode .....	35
Cell Mode Percent .....	36
Picture Retrieval Timeout .....	37
Image Capture Delay .....	39
Image Format .....	40
Image Size .....	41
Image Brightness .....	42
Image Contrast .....	44
Image Compression .....	46
Region of Interest (ROI) .....	47
INTERFACE SELECTION .....	50
<b>Interface Type .....</b>	<b>50</b>
USB-COM Interface Setup .....	50
RS-232 Interface Selection .....	51
USB Interface Selection .....	51
Keyboard Interface Selection .....	52
INTERFACE FEATURES .....	53
Maximum Host-Transmitted Message Length .....	53
RS-232 INTERFACE FEATURES .....	54
RS-232 Baud Rate .....	54
RS-232 Number of Data Bits .....	55
RS-232 Number of Stop Bits .....	55
RS-232 Parity .....	56
RS-232 Hardware Control .....	57
RS-232 Intercharacter Delay .....	58
RS-232 Software Flow Control .....	59
RS-232 Beep on ASCII BEL .....	59
Beep on Not on File .....	60
RS-232 ACK NAK Features .....	61
ACK NAK Enable .....	61
RS-232 ACK Character .....	62
RS-232 NAK Character .....	63
RS-232 Retry on ACK NAK Timeout .....	63
RS-232 ACK NAK Timeout Value .....	64
RS-232 ACK NAK Retry Count .....	65
RS-232 ACK NAK Error Handling .....	66
RS-232 Indicate Transmission Failure .....	67
RS-232 Ignore Host Commands .....	67
USB-OEM INTERFACE FEATURES .....	68
USB OEM Scanner Device Type .....	68
USB OEM Additional Interface Options .....	69
USB KEYBOARD FEATURES .....	70
Keyboard Layout .....	70
USB Keyboard Country Mode .....	70
USB Keyboard Caps Lock State .....	73
No Keyboard Support .....	74
USB Keyboard Send Control Characters .....	75
Quiet Interval .....	76
USB Keyboard Intercharacter Delay .....	77
USB Keyboard Additional Interface Options .....	77
<b>Data Editing Overview .....</b>	<b>79</b>
Please Keep In Mind... .....	79
GLOBAL PREFIX/SUFFIX .....	80
Global Prefix .....	80
Global Suffix .....	81
<b>AIM ID .....</b>	<b>82</b>
LABEL ID .....	83
Label ID Control .....	83
Setting Label ID .....	84

1 D Symbologies .....	84
Global Mid-Label ID .....	90
CASE CONVERSION .....	91
CHARACTER CONVERSION .....	92
1D Symbologies .....	93
COUPON CONTROL .....	94
Coupon Control Enable .....	94
Coupon Label Priority Timer .....	95
UPC-A .....	96
UPC-A Enable .....	96
UPC-A Number System Character Transmission .....	97
UPC-A Check Character Transmission .....	98
UPC-A Minimum Read .....	99
Expand UPC-A to EAN-13 .....	100
UPC-E .....	101
UPC-E Enable .....	101
UPC-E Number System Character Transmission .....	102
UPC-E Check Character Transmission .....	103
Expand UPC-E to UPC-A .....	104
Expand UPC-E to EAN-13 .....	104
UPC-E Minimum Read .....	105
EAN-13 .....	106
EAN-13 Enable .....	106
EAN-13 First Character Transmission .....	107
EAN-13 Check Character Transmission .....	108
EAN-13 ISBN Conversion Enable .....	109
EAN-13 Minimum Read .....	110
EAN-8 .....	111
EAN-8 Enable .....	111
EAN-8 Check Character Transmission .....	112
Expand EAN-8 to EAN-13 .....	113
EAN-8 Minimum Read .....	114
EAN-8 Guard Insertion .....	115
EAN-8 Guard Substitution .....	116
EAN-8/Jan-8 Both Guards Substitution .....	117
EAN-8 Stitch Exact Label Halves .....	118
EAN-8 Stitch Unlike Label Halves .....	119
EAN-8 Minimum Segment Length .....	120
EAN-8 Decoding Levels .....	122
OTHER UPC/EAN OPTIONS .....	123
In-Store Printed Label Minimum Read .....	123
UPC/EAN Correlation .....	124
UPC/EAN Guard Insertion .....	125
UPC/EAN Stitch Exact Label Halves .....	126
UPC/EAN Stitch Unlike Label Halves .....	127
UPC/EAN Minimum Segment Length .....	128
Price Weight Check .....	130
Enable EAN Two Label .....	131
EAN Two Label Minimum Read .....	132
EAN Two Label Combined Transmission .....	133
Add-ons .....	134
P2 Add-on Minimum Read .....	135
P5 Add-on Minimum Read .....	137
UPC/EAN Composites .....	139
GTIN .....	140
GTIN Enable .....	140
GS1 DATABAR .....	141
DATABAR OMNIDIRECTIONAL .....	141
DataBar Omnidirectional Enable .....	141
DataBar Omnidirectional/EAN-128 Emulation .....	142
DataBar Omnidirectional 2D Component Enable .....	143

DataBar Omnidirectional Minimum Read .....	144
DataBar Omnidirectional Double Read Timeout .....	145
DATABAR LIMITED .....	146
DataBar Limited Enable .....	146
DataBar Limited Minimum Read .....	147
DataBar Limited 2D Component Enable .....	148
DataBar Limited EAN128 Emulation Enable .....	149
DATABAR EXPANDED .....	150
DataBar Expanded Enable .....	150
DataBar Expanded EAN-128 Emulation .....	151
DataBar Expanded 2D Component Enable .....	152
DataBar Expanded Minimum Read .....	153
DataBar Expanded Length Control .....	154
DataBar Expanded Length 1 .....	154
DataBar Expanded Length 2 .....	155
DataBar Expanded Reverse Retry .....	156
CODE 39 .....	157
Code 39 Enable .....	157
Code 39 Start Stop Character Transmission .....	158
Code 39 Check Character Calculation .....	159
Code 39 Check Character Transmission .....	160
Code 39 Full ASCII .....	161
Code 39 Minimum Read .....	162
Code 39 Correlation .....	163
Code 39 Length Control .....	164
Code 39 Length 1 .....	165
Code 39 Length 2 .....	166
Code 39 Stitching .....	167
Code 39 Require Margins .....	168
CODE 32 ITALIAN PHARMACODE .....	169
Code 32 Italian Pharmacode Enable .....	169
Code 32 Start Stop Character Transmission .....	170
Code 32 Check Character Transmission .....	171
CODE 128 .....	172
Code 128 Enable .....	172
Code 128 Transmit Function Characters .....	173
Expand Code128 to Code 39 .....	174
Code 128 Minimum Read .....	175
Code 128 Correlation .....	176
Code 128 Length Control .....	177
Code 128 Length 1 .....	178
Code 128 Length 2 .....	179
Code 128 Stitching .....	180
EAN-128 .....	181
EAN-128 Enable .....	181
INTERLEAVED 2 OF 5 (I 2 OF 5) .....	182
Interleaved 2 of 5 (I 2 OF 5) Enable .....	182
I 2 of 5 Check Character Calculation .....	183
I 2 of 5 Check Character Transmission .....	184
I 2 of 5 Minimum Read .....	185
I 2 of 5 Correlation .....	186
I 2 of 5 Length Control .....	187
I 2 of 5 Length 1 .....	188
I 2 of 5 Length 2 .....	189
I 2 of 5 Stitching .....	190
CODABAR .....	191
Codabar Enable .....	191
Codabar Start Stop Character Transmission .....	192
Codabar Start Stop Character Set .....	193
Codabar Start Stop Character Match .....	194
Codabar Check Character Calculation .....	195

Codabar Check Character Transmission .....	196
Codabar Minimum Read .....	197
Codabar Correlation .....	198
Codabar Length Control .....	199
Codabar Length 1 .....	199
Codabar Length 2 .....	200
Codabar Stitching .....	201
Codabar Require Margins .....	202
CODE 93 .....	203
Code 93 Enable .....	203
Code 93 Minimum Read .....	204
Code 93 Correlation .....	205
Code 93 Length Control .....	206
Code 93 Length 1 .....	206
Code 93 Length 2 .....	207
Code 93 Stitching .....	208
MSI .....	209
MSI Enable .....	209
MSI Check Character Calculation .....	210
MSI Number of Check Characters .....	211
MSI Check Character Transmission .....	212
MSI Minimum Read .....	213
MSI Correlation .....	214
MSI Length Control .....	215
MSI Length 1 .....	215
MSI Length 2 .....	216
MSI Stitching .....	217
STANDARD 2 OF 5 .....	218
Standard 2 of 5 Enable .....	218
Standard 2 of 5 Check Character Calculation .....	219
Standard 2 of 5 Check Character Transmission .....	220
Standard 2 of 5 Minimum Read .....	221
Standard 2 of 5 Correlation .....	222
Standard 2 of 5 Length Control .....	223
Standard 2 of 5 Length 1 .....	223
Standard 2 of 5 Length 2 .....	224
Standard 2 of 5 Stitching .....	225
2D Codes .....	226
DATA MATRIX .....	227
Data Matrix Enable .....	227
Data Matrix Length Control .....	228
Configuring Variable Length Decoding: .....	228
Data Matrix Length 1, Length 2 Programming Instructions .....	229
GS1 Datamatrix Enable .....	230
PDF 417 .....	231
PDF 417 Enable .....	231
PDF 417 Length Control .....	232
Configuring Variable Length Decoding: .....	232
PDF 417 Length 1, Length 2 Programming Instructions .....	233
PDF 417 Read Option .....	234
MICRO PDF 417 .....	235
Micro PDF 417 Enable .....	235
Micro PDF 417 Length Control .....	236
Configuring Variable Length Decoding: .....	236
Micro PDF 417 Length 1, Length 2 Programming Instructions .....	237
Micro PDF 417 128 Emulation .....	238
QR CODE .....	239
QR Code Enable .....	239
QR Code Length Control .....	240
Configuring Variable Length Decoding: .....	240
QR Code Length 1, Length 2 Programming Instructions .....	241

QR Code URL Link Enable .....	242
GS1 QR CODE ENABLE .....	243
MICRO QR CODE .....	244
Micro QR Code Enable .....	244
Micro QR Code Length Control .....	245
Configuring Variable Length Decoding: .....	245
Micro QR Code Length 1, Length 2 Programming Instructions .....	246
AZTEC CODE .....	247
Aztec Enable .....	247
Aztec Length Control .....	248
Configuring Variable Length Decoding: .....	248
Aztec Length 1, Length 2 Programming Instructions .....	249
<b>CHAPTER 3. REFERENCES .....</b>	<b>250</b>
<b>Global Prefix/Suffix .....</b>	<b>251</b>
<b>Label ID .....</b>	<b>252</b>
<b>Length Control .....</b>	<b>253</b>
Configuring Variable Length Decoding: .....	253
Length 1, Length 2 Programming Instructions .....	253
<b>APPENDIX A. PRODUCT SPECIFICATIONS .....</b>	<b>254</b>
<b>Technical Specifications .....</b>	<b>255</b>
Decoding Capability .....	255
Electrical Specifications .....	255
Environmental .....	255
Interfaces .....	255
Optional Features .....	255
<b>Physical Characteristics .....</b>	<b>256</b>
Scanner Dimensions .....	256
<b>Reading Performance .....</b>	<b>257</b>
Reading Ranges .....	257
<b>Safety &amp; Regulatory .....</b>	<b>257</b>
<b>Utilities .....</b>	<b>257</b>
<b>Warranty .....</b>	<b>258</b>
<b>LED and Beeper Indicators .....</b>	<b>258</b>
<b>Error Codes .....</b>	<b>259</b>
<b>APPENDIX B. CABLE PINOUTS .....</b>	<b>260</b>
<b>Standard Cable Pinouts (Primary Interface Cables) .....</b>	<b>260</b>
<b>APPENDIX C. ALPHA-NUMERIC KEYPAD .....</b>	<b>261</b>
<b>APPENDIX D. FACTORY DEFAULT SETTINGS .....</b>	<b>263</b>
Factory Default Settings .....	263
<b>APPENDIX E. KEYBOARD FUNCTION KEY MAPPINGS .....</b>	<b>273</b>
USB Function Key Usage Map .....	273
<b>APPENDIX F. HOST COMMANDS .....</b>	<b>280</b>
<b>Accepting RS-232 Commands .....</b>	<b>280</b>
<b>APPENDIX G. SAMPLE SYMBOLS .....</b>	<b>281</b>
<b>1D Symbol Samples .....</b>	<b>281</b>
<b>2D Sample Symbols .....</b>	<b>283</b>
<b>Composite Sample Symbols .....</b>	<b>284</b>
<b>APPENDIX H. MICROSD CARD .....</b>	<b>285</b>
<b>microSDHC Compatibility .....</b>	<b>286</b>
microSD Card Insertion .....	286
microSD Card Removal .....	286



<b>Autorun File Processing</b> .....	<b>287</b>
<b>microSD Function Summary</b> .....	<b>287</b>
<b>microSD Function Details</b> .....	<b>288</b>
From Scanner to microSD Card .....	288
Capture and save an image to a microSD card by button press .....	288
Export a Configuration file from the Scanner to the microSD card .....	288
From microSD Card to Scanner .....	289
Application code load to scanner .....	289
Configuration load to scanner .....	289

## **APPENDIX I. HANDHELD DATA FORMAT REQUIREMENTS** ..... **290**

<b>Handheld Data Format Requirements General</b> .....	<b>290</b>
Datalogic Handheld Data Format Requirements .....	290
GS1 DataBar Omnidirectional .....	290
GS1 DataBar Expanded .....	291
UPC-A .....	291
UPC-A with 2-Digit Supplemental .....	291
UPC-A with 5-Digit Supplemental .....	291
UPC-E .....	291
UPC-E with 2-Digit Supplemental .....	291
UPC-E with 5-Digit Supplemental .....	291
EAN-8 .....	291
EAN-8 with 2-Digit Supplemental .....	291
EAN-8 with 5-Digit Supplemental .....	292
EAN-13 .....	292
EAN-13 with 2-Digit Supplemental .....	292
EAN-13 with 5-Digit Supplemental .....	292
Code 39 .....	292
Code 39-Pharmacode .....	292
I 2 of 5 .....	292
Codabar .....	293
Code 128 .....	293
MSI .....	293
Code 93 .....	293
PDF417 .....	293
AIM Formats .....	294
UPC-A .....	294
UPC-E .....	294
EAN-13 .....	294
EAN-8 .....	294
2-Digit Supplemental .....	294
5-Digit Supplemental .....	294
Bookland .....	295
Code 39 .....	295
Codabar .....	295
MSI .....	295
Code 93 .....	295
RSS-14 .....	296
RSS Expanded .....	296
I 2 of 5 .....	296
Code 128 / EAN128 .....	296
PDF417 .....	296
"Unknown" AIM ID (an AIM ID which is not specified above) .....	296

## **APPENDIX J. ASCII CHART** ..... **297**

---

# NOTES

# CHAPTER 1

## GETTING STARTED

---

The Magellan™ 3450VSi On-Counter Vertical Presentation Scanner is designed for small counter retail checkout environments where there is a relatively high number of transactions with a fairly small number of items per transaction. The scanner has a reduced footprint, allowing more room for item merchandising of high margin impulse items clustered around the POS (Point of Sale).

### ABOUT THIS MANUAL

This manual provides advanced user information, including connection, programming, product and cable specifications, and other useful references. For additional information, such as installation, maintenance, troubleshooting and warranty information, see the Quick Reference Guide (QRG). Copies of other publications for this product are downloadable free of charge from the website listed on the back cover of this manual.

On leaving the factory, units are programmed for the most common terminal and communications settings. If you need to change these settings, custom programming can be accomplished by scanning the bar codes in this guide. The most common default settings for features/options are indicated by a green arrow.

### Manual Conventions

The symbols listed below are used in this manual to notify the reader of key issues or procedures that must be observed when using the scanner:



**NOTES** contain information necessary for properly diagnosing, repairing and operating the scanner.



The **CAUTION** symbol advises you of actions that could damage equipment or property.

## CONNECTING THE SCANNER

The scanner kit you ordered to match your interface should provide a compatible cable for your installation. Alternatively, if your scanner receives Power Off the Terminal (POT) it might be possible to connect using a cable from a previously existing installation (except USB). For Powering Off Terminal (POT), please reference [Electrical Specifications](#) on page A-255 of Appendix A to ensure your Host Terminal's power supply is compatible, or contact Datalogic Technical Support. Use the instructions below when you're ready to connect the scanner to the terminal, PC or other host device.

Upon completing the connection via the appropriate interface instructions below, proceed to the section of this manual and scan the bar code to select the correct interface type.

**RS-232 Serial Connection :** Turn off power to the terminal/PC and connect the scanner to the terminal/PC serial port via the RS-232 cable as shown in Figure 1. If the terminal will not support POT (Power Off the Terminal) to supply scanner power, use the approved power supply (AC Adapter).

**Figure 1. Connecting the Scanner**

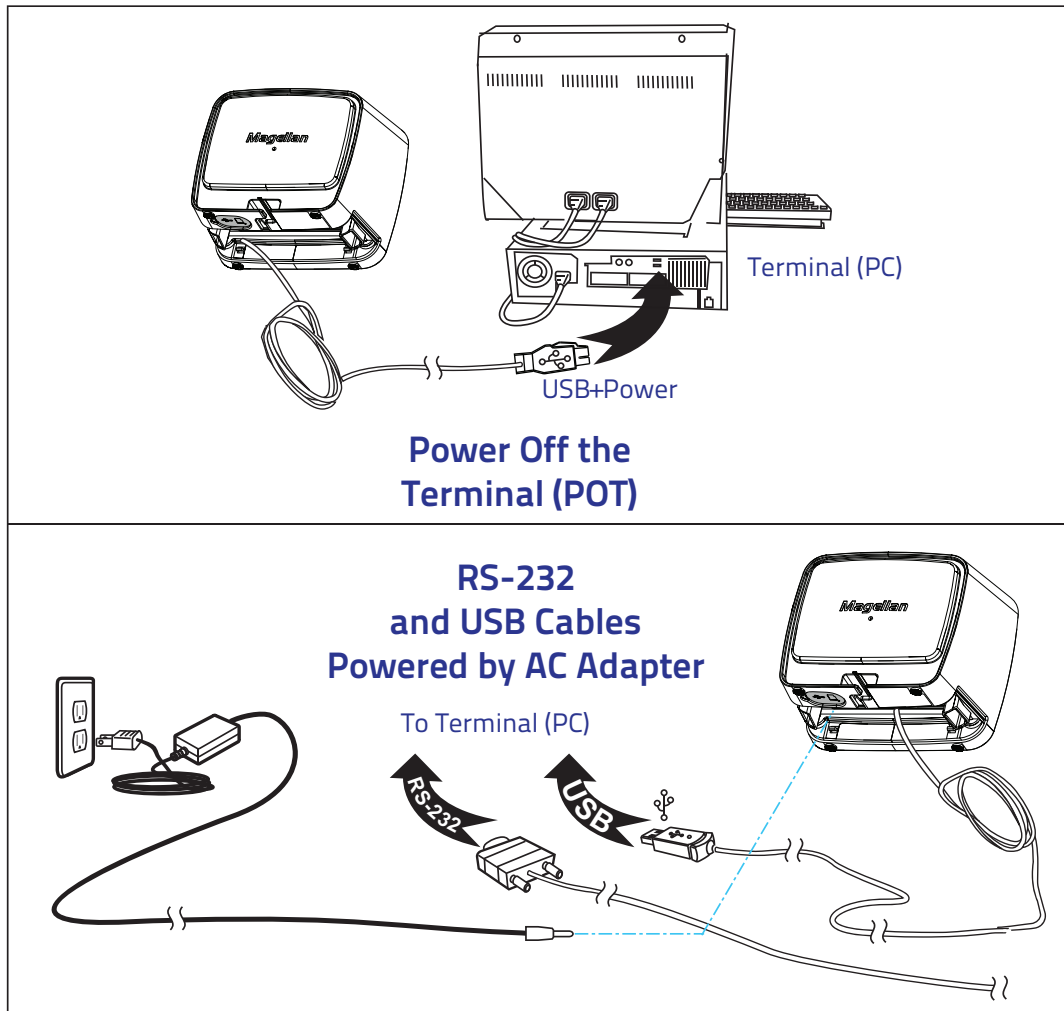

**USB Connection :** Connect the scanner to a USB port on the terminal/PC using the correct USB cable for the interface type you ordered. Reference Figure 1 on page 2.



**NOTE:** USB installations may require a power connection via an approved A/C Adapter as shown. For example, this would be the case if the scanner is connected along with a number of other devices to a non-powered USB hub.

Figure 2. Scanner Features - Front View

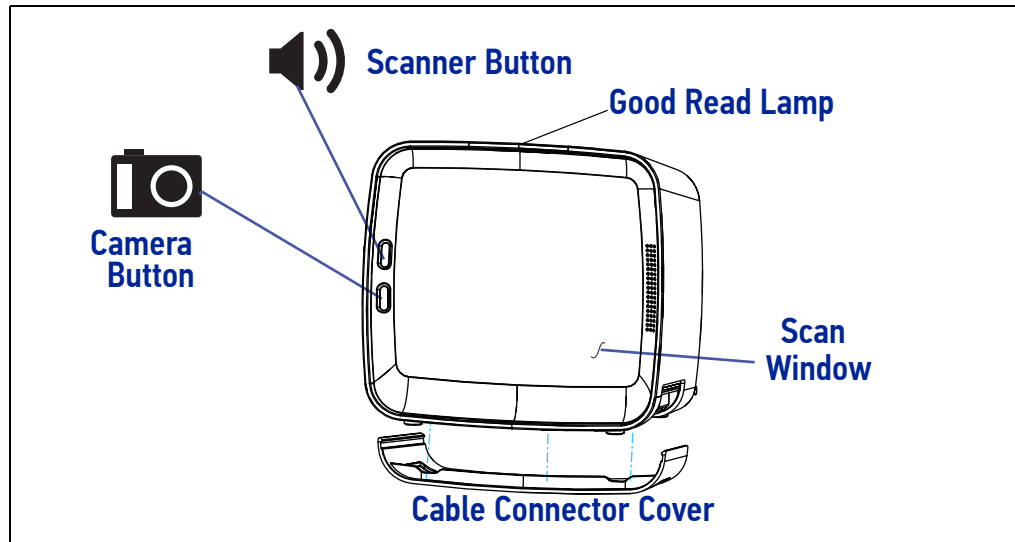

Figure 3. Scanner Features - Back View

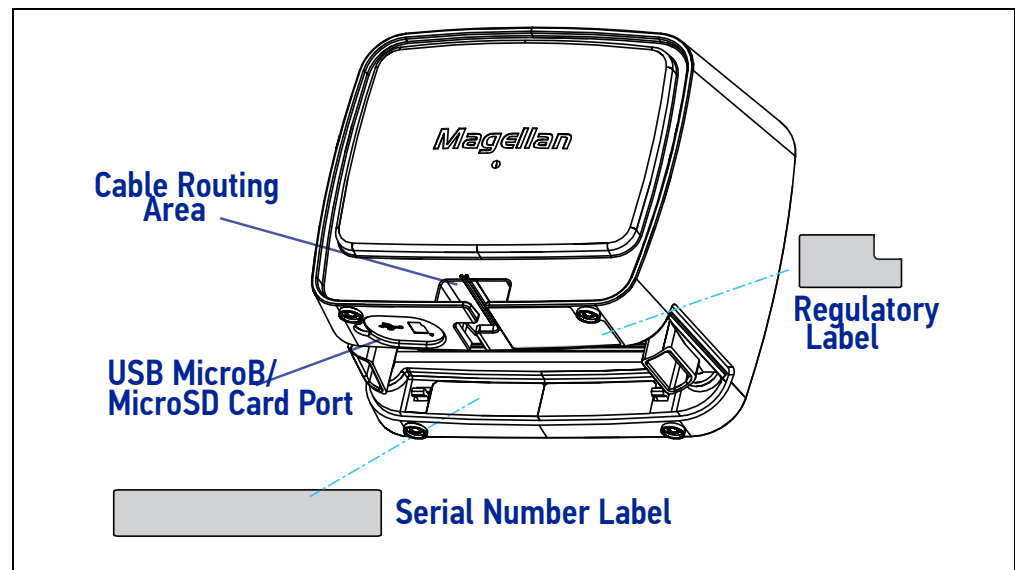
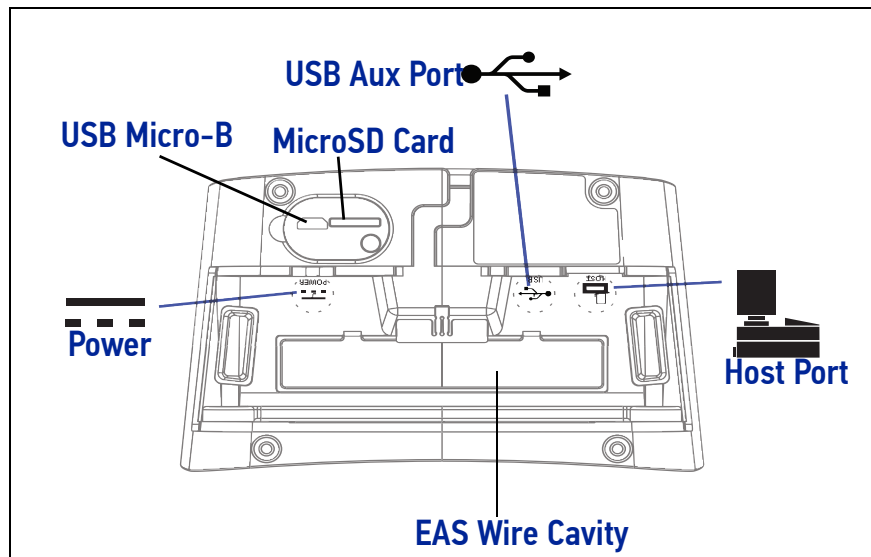

Figure 4. Scanner Features - Bottom View



## MOUNT INSTALLATION

Options for mounting the scanner to a wall or countertop include an L-Bracket or an adjustable riser. Figure 5 shows the scanner being seated in an L-Bracket.

Figure 5. L-Bracket Mount

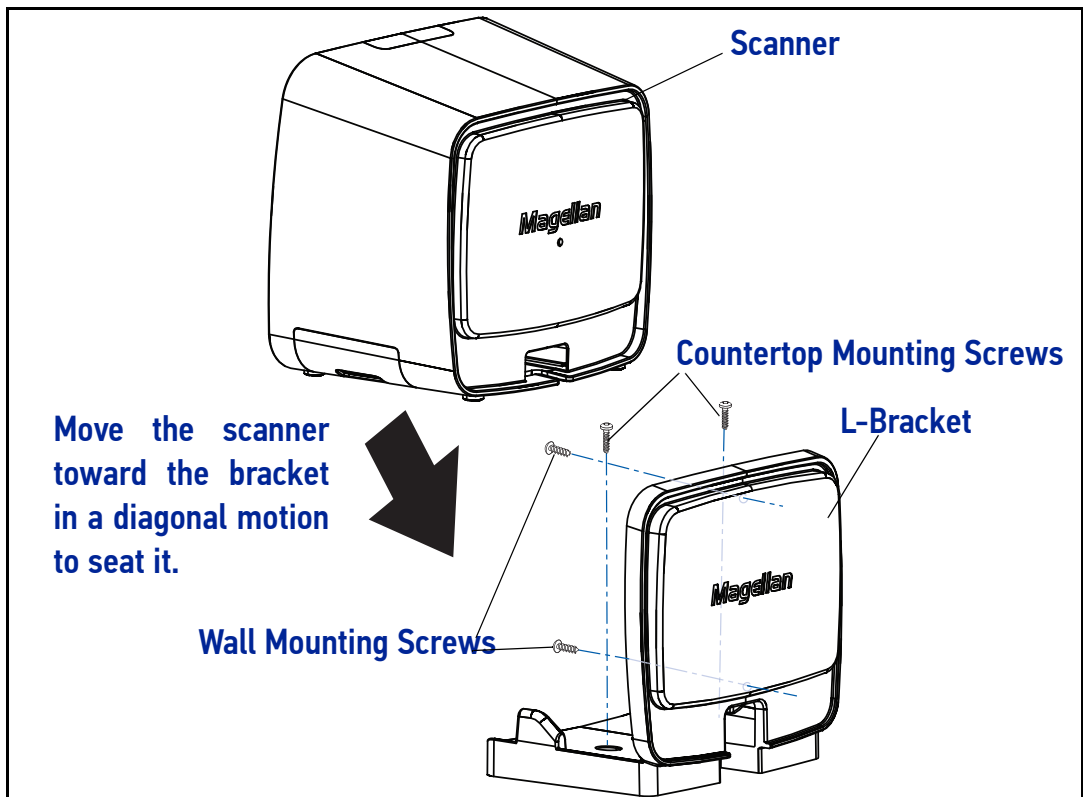

## Wall Mount

When using the L-Bracket for wall mount installation, pre-drill the center of the two wall mount bosses (shown in Figure 6) using a 4.5mm or 11/64" drill.

Attach the L-Bracket to the wall over the two drilled holes shown in Figure 6 using two pan head M4 or #8 screws (8.2mm or 5/16" maximum head diameter) with threads that suit the mounting surface of the wall.



**CAUTION: Do not remove the plastic ribs around the mounting holes and do not overtighten the mounting screws as this may damage the wall mount.**

Figure 6. Wall Mount Drill Location

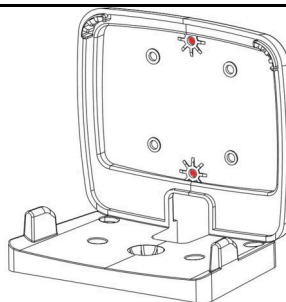

## Countertop Mount

If using the L-Bracket alone for countertop installation, secure the bracket in place using two screws through the bottom face of the bracket (see Figure 5). It is recommended to use two pan head (8.2mm or 5/16" maximum head diameter) #8 screw with a thread profile that suits the mounting surface material in the countertop.



**CAUTION: Do not use a countersink type of screw head. Damage will occur from use of a countersunk screw head in the plastic screw bosses**

## Adjustable Riser

The Adjustable Riser may be attached as shown.

**Figure 7. Using the Adjustable Riser**

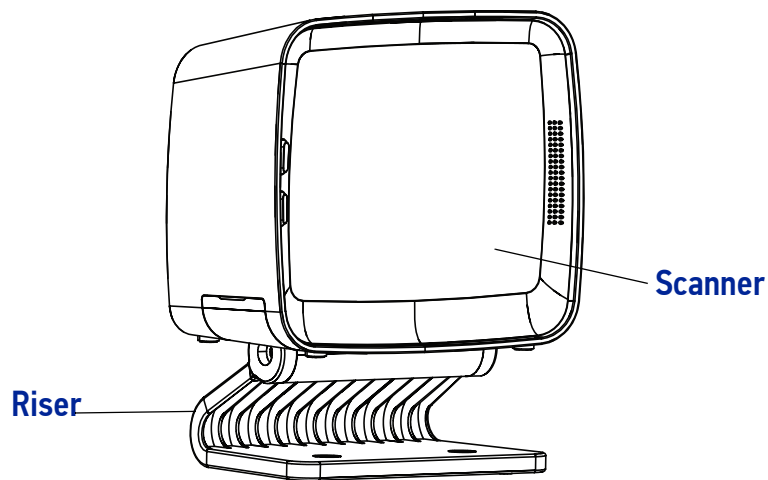



# CHAPTER 2

## PROGRAMMING

---

### INTRODUCTION TO LABEL PROGRAMMING

The programming bar code labels contained in this manual will allow you to customize and configure features and settings for your scanner. To ensure full compatibility and proper function, use only the programming bar codes in this manual and other product-specific publications to program scanner features.

This manual has been developed to make it quick and easy for users of all levels to find the information needed to understand and configure features. The following descriptions will help you to determine where to go from here.

### UNDERSTANDING THE BASICS

If you have little or no prior experience with programming using bar code labels, you should review the first few pages of this section to familiarize yourself with the basics of scanner programming before performing any changes to your configuration.

#### Using the Programming Bar Codes

The scanner is typically factory-configured with a set of default features standard to the interface type you ordered. After scanning the interface bar code from the section, you can select other options and customize your scanner through use of the instructions and programming bar codes available in that section and also the [Data Editing](#) and [1D Symbolologies](#) chapters of this manual.

This manual contains feature descriptions and bar codes which allow you to reconfigure your scanner. Some programming bar code labels, like the label below for resetting defaults, require only the scan of that single label to enact the change. Most of the programming labels in this manual, however, require the scanner to be placed in Programming Mode prior to scanning them. Scan an Enter/Exit Programming Mode bar code once to enter Programming Mode. Once the scanner is in Programming Mode, you can scan a number of parameter settings before scanning the Enter/Exit Programming Mode bar code a second time, which will then accept your changes, exit Programming Mode, reset the scanner and return it to normal operation.

#### Resetting the Standard Product Defaults

If you are unsure of what programming options are in your scanner, or you've changed some options and want the factory settings restored, scan the *Standard Product Default Settings* bar code below. This will copy the factory configuration for the currently active interface to the current configuration.



Standard Product Default Settings

The programming section lists the factory default settings for each of the menu commands for the standard RS-232 interface on the following pages, indicated by a green arrow. Exceptions to default settings for the other interfaces can be found in [Appendix D, Factory Default Settings](#).

## Using a Bar Code Mask

The programming bar codes in this manual have been placed as multiples per page. In order to present them only one at a time to the scanner, a bar code mask is provided on the opposite side of this page.

## Going Green

Thank you for using the bar code mask on the opposite side of this page. This manual has been formatted to minimize the quantity of pages needed to provide all of the programming bar codes available for this product.



## BAR CODE MASK

Cut a hole in this page and remove it from the manual as indicated to create a sleeve through which bar codes (starting in the following section) can be individually viewed and scanned, if needed. It is important that only one bar code at a time be presented to the scanner.

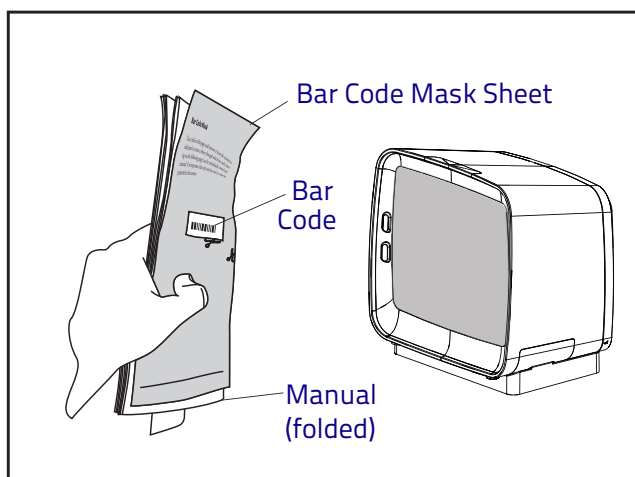
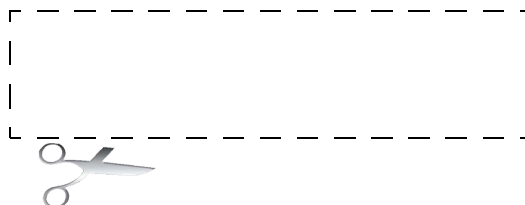

# GENERAL SCANNER FEATURES

## SECTION CONTENTS

### **SCANNING FEATURES** starting on page 11

- |  |   |
|--|---|
| <ul style="list-style-type: none"> <li>•1D Double Read Timeout</li> <li>•2D Double Read Timeout</li> <li>•Digital Watermark (Digimarc®) Features               <ul style="list-style-type: none"> <li>- Digital Watermark (Digimarc) Enable</li> <li>- Digital Watermark (Digimarc) Double Read Timeout</li> <li>- Digital Watermark (Digimarc) Data Format</li> </ul> </li> </ul> | <ul style="list-style-type: none"> <li>•Sleep Mode Timer</li> <li>•1D Inverse Read Control</li> <li>•2D Inverse Read Control</li> <li>•Reading Illumination Duration</li> </ul> |
|--|---|

### **LED AND BEEPER INDICATORS** starting on page 19

- |  |   |
|--|---|
| <ul style="list-style-type: none"> <li>•Power On Alert</li> <li>•Illumination During Disable Mode</li> <li>•Object Sense Control</li> <li>•Exposure Control</li> <li>•External Read Indicator (ERI)</li> <li>•ERI Timeout</li> <li>•Good Read LED Idle State</li> <li>•Scanner Control Button Options</li> </ul> | <ul style="list-style-type: none"> <li>•Good Read Beep Control</li> <li>•Good Read Beep Frequency</li> <li>•Good Read Beep Length</li> <li>•Good Read Beep Volume</li> <li>•Good Read When to Indicate</li> </ul> |
|--|---|

### **•HOST DOWNLOAD TO HANDHELD** starting on page 31

- Handheld Host Download Timeout

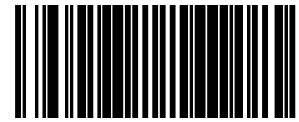

## SCANNING FEATURES

### 1D Double Read Timeout

The 1D Double Read Timeout feature specifies the minimum allowable time which must pass before reading the same 1D label again (e.g. two identical items in succession).

To set the Double Read Timeout:

1. Scan the Enter/Exit Programming Mode bar code.
2. Scan your selection from the bar codes below. You'll need to cover any unused bar codes on this and the facing page to ensure that the scanner reads only the bar code you intend to scan.
3. Complete the programming sequence by scanning the Enter/Exit Programming Mode bar code.



**NOTE: If the incidence of multiple reads is not acceptable, increase the Double Read Timeout setting to a higher value.**



1D Double Read Timeout = 300ms



★ 1D Double Read Timeout = 400ms



1D Double Read Timeout = 600ms



1D Double Read Timeout = 800ms

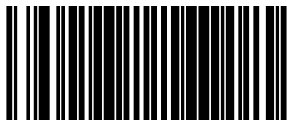

## 2D Double Read Timeout

The 2D Double Read Timeout feature specifies the minimum allowable time which must pass before reading the same 2D label again (e.g. two identical items in succession).

To set this feature:

1. Scan the Enter/Exit Programming Mode bar code.
2. Scan your selection from the bar codes below. You'll need to cover any unused bar codes on this and the facing page to ensure that the scanner reads only the bar code you intend to scan.
3. Complete the programming sequence by scanning the Enter/Exit Programming Mode bar code.



**NOTE: If the incidence of multiple reads is not acceptable, increase the Timeout setting to a higher value.**



2D Double Read Timeout = 300ms



2D Double Read Timeout = 400ms



2D Double Read Timeout = 600ms



★ 2D Double Read Timeout = 700ms



2D Double Read Timeout = 800ms

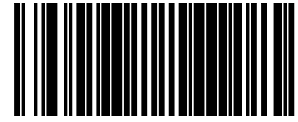

## DIGITAL WATERMARK (DIGIMARC®) FEATURES

### Digital Watermark (Digimarc) Enable

Enables/Disables the ability of the scanner to decode Digimarc® Digital Watermarks.

To set this feature:

1. Scan the Enter/Exit Programming Mode bar code.
2. Scan your selection from the bar codes below. You'll need to cover any unused bar codes on this and the facing page to ensure that the scanner reads only the bar code you intend to scan.
3. Complete the programming sequence by scanning the Enter/Exit Programming Mode bar code.



**NOTE: The Digimarc Digital Watermark feature requires the purchase of a special software license to activate it. For more information, please contact your Datalogic representative.**



Digital Watermark (Digimarc) = Disable



★ Digital Watermark (Digimarc) = Enable

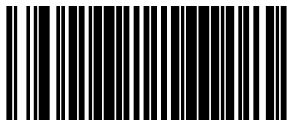

## Digital Watermark (Digimarc) Double Read Timeout

Specifies the minimum allowable time which must pass before reading the same Digital Watermark (Digimarc) label again (e.g. two identical items in succession).

To set this feature:

1. Scan the Enter/Exit Programming Mode bar code.
2. Scan your selection from the bar codes below. You'll need to cover any unused bar codes on this and the facing page to ensure that the scanner reads only the bar code you intend to scan.

Complete the programming sequence by scanning the Enter/Exit Programming Mode bar code.



**NOTE: If the incidence of multiple reads is not acceptable, increase the Double Read Timeout setting to a higher value.**



Digimarc Double Read Timeout = 0.3 Seconds



Digimarc Double Read Timeout = 0.4 Seconds



★ Digimarc Double Read Timeout = 0.5 Seconds



Digimarc Double Read Timeout = 0.7 Seconds



Digimarc Double Read Timeout = 1 Second



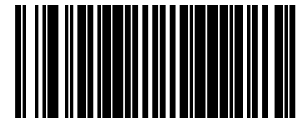

## Digital Watermark (Digimarc) Data Format

Selects the format for the watermark data. Choices are:

- Compatibility mode
- Databar-14
- Native

1. Scan the Enter/Exit Programming Mode bar code.
2. Scan your selection from the bar codes below. You'll need to cover any unused bar codes on this and the facing page to ensure that the scanner reads only the bar code you intend to scan.
3. Complete the programming sequence by scanning the Enter/Exit Programming Mode bar code.



**NOTE: The Digital Watermark feature must be enabled for decode functionality.**



★ Digital Watermark (Digimarc) Data Format = Compatibility mode



Digital Watermark (Digimarc) Data Format = Databar-14 mode



Digital Watermark (Digimarc) Data Format = Native mode

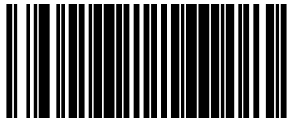

## Sleep Mode Timer

This feature specifies the amount of time of inactivity (with no label reads) before the scanner enters sleep mode.

To set this feature:

1. Scan the Enter/Exit Programming Mode bar code.
2. Scan the bar code, [Set Sleep Mode Timer](#) below. You'll need to cover any unused bar codes on this and the facing page to ensure that the scanner reads only the bar code you intend to scan.
3. Scan the appropriate digits from the [Alpha-Numeric Keypad in Appendix C](#) that represent the desired time interval. The selectable range is 000-255 in 15 second increments. Pad all numbers with leading zeros to yield a three-digit entry (000-255).
4. Scan the Enter/Exit Programming Mode bar code to exit Programming Mode.

★ Default setting for this feature is: 5 minutes



Set Sleep Mode Timer

## 1D Inverse Read Control

This configuration item is used to toggle inverted label reading for 1D bar codes, for example, a label printed as white on black as opposed to black on white.

To set this feature:

1. Scan the Enter/Exit Programming Mode bar code.
2. Scan your selection from the bar codes below. You'll need to cover any unused bar codes on this and the facing page to ensure that the scanner reads only the bar code you intend to scan.
3. Complete the programming sequence by scanning the Enter/Exit Programming Mode bar code.



★ 1D Inverse Read Control = Disable



1D Inverse Read Control = Enable

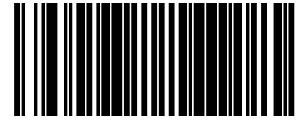

## 2D Inverse Read Control

This configuration item is used to toggle inverted label reading for 2D bar codes, for example, a label printed as white on black as opposed to black on white.

To set this feature:

1. Scan the Enter/Exit Programming Mode bar code.
2. Scan your selection from the bar codes below. You'll need to cover any unused bar codes on this and the facing page to ensure that the scanner reads only the bar code you intend to scan.
3. Complete the programming sequence by scanning the Enter/Exit Programming Mode bar code.



★ 2D Inverse Read Control = Disable



2D Inverse Read Control = Enable

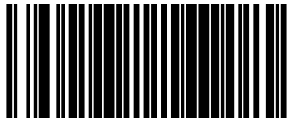

## READING ILLUMINATION DURATION

This feature specifies how long the illumination stays on after a label or label segment is read.

To set this feature:

1. Scan the Enter/Exit Programming Mode bar code.
2. Scan your selection from the bar codes below. You'll need to cover any unused bar codes on this and the facing page to ensure that the scanner reads only the bar code you intend to scan.
3. Complete the programming sequence by scanning the Enter/Exit Programming Mode bar code.



Reading Illumination Duration = 1 Seconds



Reading Illumination Duration = 3 Seconds



★ Reading Illumination Duration = 5 Seconds

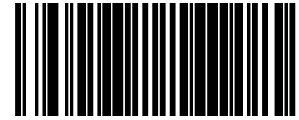

## LED AND BEEPER INDICATORS

### Power On Alert

Disables or enables the indication that the scanner has finished all its power up tests and is now ready for operation (usually a single beep).



**NOTE: This feature is configurable so the beep can be replaced with a .wav file.**



Power-up Tone Control = No Tone



★ Power-up Tone Control = Play Tone

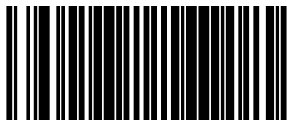

## Illumination During Disable Mode

This feature allows illumination to be turned off when the scanner is in “disable” mode. It determines if the imager illumination is controlled by host interface enable/disable commands.

**Disable** = Illumination is not controlled by host enable/disable commands, illumination stays on when disabled.

**Enable** = Illumination is controlled by host enable/disable commands, illumination is on when enabled and off when disabled.

To set this feature:

1. Scan the Enter/Exit Programming Mode bar code.
2. Scan your selection from the bar codes below.
3. Complete the programming sequence by scanning the Enter/Exit Programming Mode bar code.



Illumination During Disable Mode = Disable



★ Illumination During Disable Mode = Enable

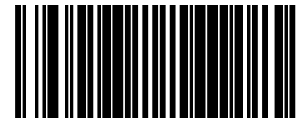

## Object Sense Control

This feature determines whether the main illumination is controlled by the Object Sensing system, or alternatively, stays continuously on.

**Enable** = Illumination is controlled by using Object Sense

**Disable** = Normal illumination is used but it goes off during sleep mode / disable mode

To set this feature:

1. Scan the Enter/Exit Programming Mode bar code.
2. Scan your selection from the bar codes below. You'll need to cover any unused bar codes on this and the facing page to ensure that the scanner reads only the bar code you intend to scan.
3. Complete the programming sequence by scanning the Enter/Exit Programming Mode bar code.



★ Object Sense Control = Enable



Object Sense Control =Disable

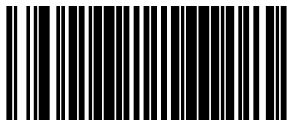

## Exposure Control

This feature controls the depth of field through exposure adjustment. Contact Customer Support for more details about this feature.

To set this feature:

1. Scan the Enter/Exit Programming Mode bar code.
2. Scan your selection from the bar codes below. You'll need to cover any unused bar codes on this and the facing page to ensure that the scanner reads only the bar code you intend to scan.
3. Complete the programming sequence by scanning the Enter/Exit Programming Mode bar code.



Short depth of field



Medium depth of field



★ Long depth of field



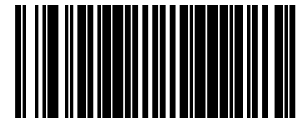

## External Read Indicator (ERI)



**NOTE: This feature is available only through use of a special cable.**



★ ERI Active State = Active Low



ERI Active State = Active High

## ERI Timeout

Specifies the amount of time the External Read Indicator (ERI) signal is held active for a good read. Sets the ERI timeout duration using hex values from 000 to 255 in increments of ten milliseconds (10ms or 0.01 seconds).

To configure this feature:

1. Scan the “Enter/Exit Programming Mode” bar code above to place the unit in Programming Mode.
2. Scan “Set ERI Timeout,” followed by the two digits (zero padded) from the [Alpha-Numeric Keypad in Appendix C](#) representing the desired time value.
3. Exit programming mode by scanning the “Enter/Exit Programming Mode” bar code again.

Default setting for this feature is:

★ 002 -20ms



Set ERI Timeout

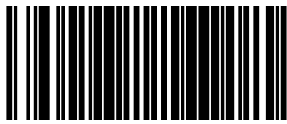

## Good Read LED Idle State

This feature specifies the state of the green scanner LEDs when the scanner is idle and ready to read a label. Options are:

- Off
- On dim

To set the Scanner LEDs Idle State:

1. Scan the Enter/Exit Programming Mode bar code.
2. Scan your selection from the bar codes below. You'll need to cover any unused bar codes on this and the facing page to ensure that the scanner reads only the bar code you intend to scan.
3. Complete the programming sequence by scanning the Enter/Exit Programming Mode bar code.



Scanner LED Idle State = Off



★ Scanner LED Idle State = On Dim

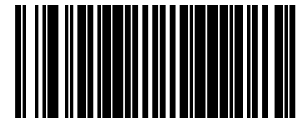

## Scanner Control Button Options

Configure the Scanner Control Button to one of the following modes of operation:

- Enable all functions: Volume, tone, diagnostics and reset.
- Enable only volume, tone and reset.
- Enable reset only.
- Disable all button functions

To set the desired Scanner Control Button Option:

1. Scan the Enter/Exit Programming Mode bar code.
2. Scan your selection from the bar codes below. You'll need to cover any unused bar codes on this and the facing page to ensure that the scanner reads only the bar code you intend to scan.
3. Complete the programming sequence by scanning the Enter/Exit Programming Mode bar code.



Scanner Control Button = Enable All Functions



★ Scanner Control Button = Enable Only Volume Tone and Reset



Scanner Control Button = Enable Reset Only



Scanner Control Button = Disable All Functions

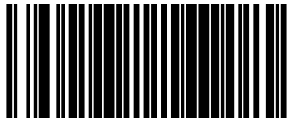

ENTER/EXIT PROGRAMMING MODE

---

## Good Read Beep Control

This feature enables/disables scanner beep upon successfully decoding of a label.

To set this feature:

1. Scan the Enter/Exit Programming Mode bar code.
2. Scan your selection from the bar codes below. You'll need to cover any unused bar codes on this and the facing page to ensure that the scanner reads only the bar code you intend to scan.
3. Complete the programming sequence by scanning the Enter/Exit Programming Mode bar code.



Good Read Beep Control = Disable



★ Good Read Beep Control = Enable

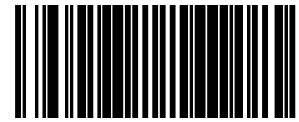

## Good Read Beep Frequency

Adjusts the scanner's good read beep to sound at low, medium, or high frequency (controls the beeper's pitch/tone).

- Low
- Medium
- High

To set this feature:

1. Scan the Enter/Exit Programming Mode bar code.
2. Scan your selection from the bar codes below. You'll need to cover any unused bar codes on this and the facing page to ensure that the scanner reads only the bar code you intend to scan.
3. Complete the programming sequence by scanning the Enter/Exit Programming Mode bar code.



Good Read Beep Frequency = Low



★ Good Read Beep Frequency = Medium



Good Read Beep Frequency = High

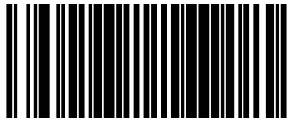

## Good Read Beep Length

Specifies the duration of a good read beep.

To set this feature:

1. Scan the Enter/Exit Programming Mode bar code.
2. Scan the bar code, [Set Good Read Beep Length](#). You'll need to cover any unused bar codes on this and the facing page to ensure that the scanner reads only the bar code you intend to scan.
3. Scan the appropriate digits from the [Alpha-Numeric Keypad in Appendix C](#) that represent the desired good read beep length setting. The selectable range is 1-255, which is the timeout in 10-millisecond increments. Times have a tolerance of +/- 25%. Pad all single and double digit numbers with leading zeroes to yield a three-digit entry (001-255).

Examples:

001 = 10ms

005 = 50ms

040 = 400ms

4. The scanner will automatically exit Programming Mode when the appropriate amount of digits have been scanned.



Set Good Read Beep Length

Default setting for this feature is:

★ 008 - 80ms

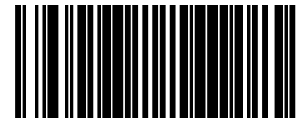

## Good Read Beep Volume

Selects the beeper volume upon a good read beep. There are five selectable volumes, with each volume increment adding approximately five decibels to the previous level:

- Low
- Medium Low
- Medium
- Medium High
- High

To set this feature:

1. Scan the Enter/Exit Programming Mode bar code.
2. Scan your selection from the bar codes below. You'll need to cover any unused bar codes on this and the facing page to ensure that the scanner reads only the bar code you intend to scan.
3. Complete the programming sequence by scanning the Enter/Exit Programming Mode bar code.



Good Read Beep Volume = Low

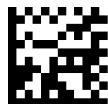

Good Read Beep Volume = Medium Low



★ Good Read Beep Volume = Medium



Good Read Beep Volume = Medium High



Good Read Beep Volume = High

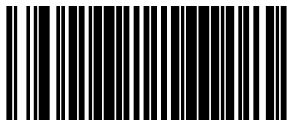

## Good Read When to Indicate

This feature specifies when the scanner will provide indication (beep and/or flash its green LEDs) upon successfully reading a bar code.

- Good Read = Indicate after decode.
- Good Read = Indicate after transmit.
- Good Read = Indicate after CTS goes inactive, then active.  
This mode applies to RS-232 STD and RS-232 WN interfaces only. If set in other interfaces, “Indicate after decode” mode will be implemented.
- Good Read = Indicate after each output structure proofed.  
When beeping after each output structure decoded, if there are multiple output structures, there is a delay after the beep has finished. This delay is equal to the [Good Read Beep Length](#).

To set the Good Read When to Indicate feature:

1. Scan the Enter/Exit Programming Mode bar code.
2. Scan the desired mode bar code from those provided below You'll need to cover any unused bar codes on facing pages to ensure that the scanner reads only the bar code you intend to scan.
3. Complete the programming sequence by scanning the Enter/Exit Programming Mode bar code.



★ Good Read When to Indicate = After Decode



Good Read When to Indicate = After Transmit



Good Read When to Indicate = After CTS goes Inactive,  
Then Active



Good Read When to Indicate = After Each Output  
Structure Proofed



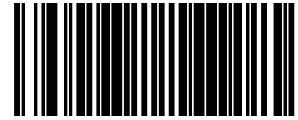

## Host Download to Handheld

Attached Datalogic handheld scanners can be updated via the host port. Contact Technical Support for details.

## Handheld Host Download Timeout

This feature sets the timeout (in seconds) to wait for a response from the handheld when performing a host download to the handheld.

To set this feature:

1. Scan the Enter/Exit Programming Mode bar code.
2. Scan the bar code below, Set Handheld HDL Timeout. You'll need to cover any unused bar codes on this and the facing page to ensure that the scanner reads only the bar code you intend to scan.
3. Scan the appropriate digits from the [Alpha-Numeric Keypad in Appendix C](#) that represent the desired delay. The selectable range is 001-255, which is the delay in 1-second increments. Pad all single and double digit numbers with leading zeroes to yield a three-digit entry (001-255).
4. Complete the programming sequence by scanning the Enter/Exit Programming Mode bar code.

Examples:

002 = 2 seconds

005 = 5 seconds

015 = 15 seconds

★ Default setting for this feature is: 15 seconds



Set Handheld HDL Timeout

# IMAGING FEATURES

## SECTION CONTENTS

### **IMAGING FEATURES** starting on page 33

- Image Capture to the Host by Host Command
- Image Capture to the Host by Camera Button
  - Camera Button Mode
  - Image Destination
- Cell Phone Mode
- Cell Mode Percent
- Picture Retrieval Timeout
- Image Capture Delay
- Image Format
- Image Size
- Image Brightness
- Image Contrast
- Image Compression
- Region of Interest (ROI)

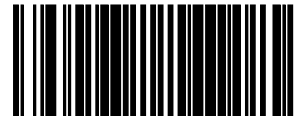

## IMAGING FEATURES

### Image Capture to the Host by Host Command

This feature is only available for RS-232 and USB COM interfaces.



**NOTE: If the USB COM interface has been selected, follow the instructions in USB-COM Interface Setup.**

The host command format is as follows:

P<cnt>pSBC

where:

**P** - ASCII 'P' used as preamble of pass-through commands

**<cnt>** - binary value of 4 indicating 4 bytes to follow

**p** - ASCII lowercase 'p'; command to take a picture

**S** - size value of image as ASCII character

'S' == uses scanner's configuration value

'0'-VGA, (640X480)

'1'-WVGA, (752X480)

'2'-SXGA, (1280x1027)

'3'-CIF (320x240)

**B** - brightness value in ASCII

'B' == uses scanner's configuration value CI\_IMAGE\_BRIGHTNESS

else '0' thru '9' specifies brightness

**C** - contrast value in ASCII

'C' == uses scanner configuration value CI\_IMAGE\_CONTRAST

else '0' thru '9' specifies contrast

IF the image is of a type the scanner supports, capture and transmission occurs, and the command is of proper format

THEN

The scanner will transmit an ACK (0x06) to the Host in response to this command.

The image data transmission starts with a 4 byte binary field representing (Big Endian) number of bytes to follow.

If the "number of bytes to follow" value is zero, there was a problem with generating the image and the request should be retried.

ELSE

The scanner will transmit a BEL (0x07) to the Host in response to this command.

ENDIF

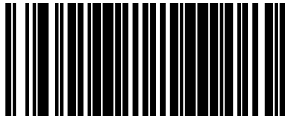

## Image Capture to the Host by Camera Button

Perform the following steps to set up the Camera Button.

1. Set the Camera Button Mode to enabled.
2. Set the Image Capture destination to host port.
3. Press the camera button.

Scanner will beep for a few seconds, then take picture and send the Image Retrieval Event label to the POS to indicate image is ready. The data content of the event label is:

**A856102000239**

The POS sends the picture retrieval command to initiate picture download from the scanner. Format of the command is:

**P\x02pG**

The scanner sends the picture to the POS with the transmission format described in the previous section, "Image Capture By Host Command".

## Camera Button Mode

This feature enables or disables the camera button.



★ Camera Button Mode = Disabled



Camera Button Mode = Enable

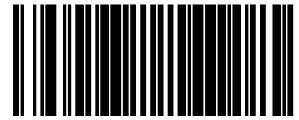

## Image Destination

Specifies the destination for pictures/images taken with a camera button press.



★ Image Destination = Disable



Image Destination = SD card<sup>a</sup>



Image Destination = Host port

- a. Contact Customer Service for more information on using this feature.

## Cell Phone Mode

Enables/disables the operating mode for mobile phone read.

When cell phone mode is enabled, the scanner stays on regardless of host command or button push. It will not enter sleep mode.



Cell Phone Mode = Disable



★ Cell Phone Mode = Enable (Always On)

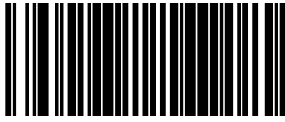

## Cell Mode Percent

Specifies the rate of frames dedicated to reading cell phones. Cell reading feature must be enabled for this to be active. The setting reflects a variable setting (or percentage) of frames dedicated to cell reading



**NOTE: As the percentage is increased, object sense (if enabled) will become less responsive. Anything above 10% will have a negative impact on scanning performance.**



★ Cell Mode Percent = 2.5% (Very Low)



Cell Mode Percent = 5% (Low)



Cell Mode Percent = 10% (Medium)

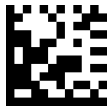

Cell Mode Percent = 20% (Medium High)



Cell Mode Percent = 50% (High)

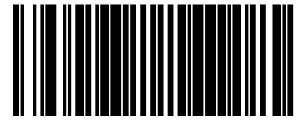

## Picture Retrieval Timeout

This feature sets the amount of time after the picture retrieval label is sent to the POS that the scanner will allow subsequent picture taking requests via button press.



**NOTE: If set to 0, the picture retrieval timeout will not be used and a picture will remain accessible until another is taken or the scanner is reset.**



Picture Retrieval Timeout = 0



Picture Retrieval Timeout = 1 second



Picture Retrieval Timeout = 2 seconds



Picture Retrieval Timeout = 3 seconds



Picture Retrieval Timeout = 4 seconds



★ Picture Retrieval Timeout = 5 seconds



Picture Retrieval Timeout = 6 seconds



Picture Retrieval Timeout = 7 seconds

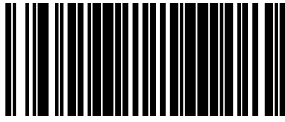

## Picture Retrieval Timeout (continued)



Picture Retrieval Timeout = 8 seconds



Picture Retrieval Timeout = 9 seconds



Picture Retrieval Timeout = 10 seconds



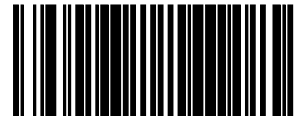

## Image Capture Delay

This feature specifies the amount of time after the image capture is initiated by a button press until the picture is taken.

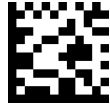

Image Capture Delay = 0 seconds



Image Capture Delay = 1 second



Image Capture Delay = 2 seconds



★ Image Capture Delay = 5 seconds



Image Capture Delay = 10 seconds

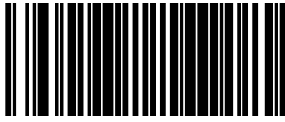

## Image Format

This feature specifies the output format for images taken using the camera function of the scanner.

Choices are:

- JPG
- BMP



★ Image Format = JPG



Image Format = BMP

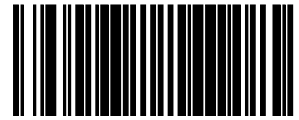

## Image Size

This feature specifies the size of the captured image. Choices are:

**VGA :** Video Graphics Array. 640 x 480 pixels.

**WVGA:** Wide Video Graphics Array, various physical sizes, 16:9 shape

**Full Size:** Maximum image height and width. Largest image.

**Half VGA:** Half of the size of a regular VGA image, 320 x 240 pixels. Smallest image.

**Scaled VGA:** Video Graphics Array, 640 x 480 pixels.

**ROI:** The size of an ROI image is determined by the value of the ROI setting. See "[Region of Interest \(ROI\)](#)" on page 47.



★ Image Size = VGA



Image Size = WVGA



Image Size = Full Size



Image Size = Half VGA



Image Size = Scaled VGA



Image Size = ROI

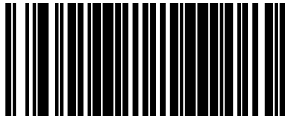

## Image Brightness

Specifies the image brightness value. The selectable range is from 0 to 10, with 10 being the brightest.



★ Image Brightness = 0



Image Brightness = 1



Image Brightness = 2



Image Brightness = 3



Image Brightness = 4



Image Brightness = 5



Image Brightness = 6



Image Brightness = 7

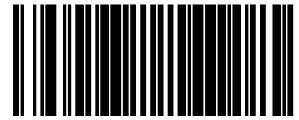

## Image Brightness — continued



Image Brightness = 8



Image Brightness = 9



Image Brightness = 10

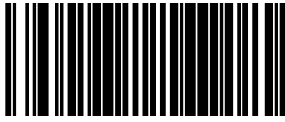

## Image Contrast

This feature sets the contrast level for a captured image. The selectable range is from 0 to 10, with 0 being the lowest and 10 being the highest contrast.



★ Image Contrast = 0



Image Contrast = 1



Image Contrast = 2



Image Contrast = 3



Image Contrast = 4



Image Contrast = 5



Image Contrast = 6



Image Contrast = 7

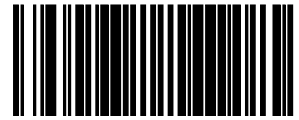

## Image Contrast — continued



Image Contrast = 8



Image Contrast = 9



Image Contrast = 10

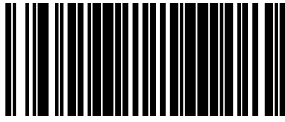

## Image Compression

Specifies the starting image compression factor.



Image Compression = 5



Image Compression = 10



Image Compression = 25



Image Compression = 50



Image Compression = 70



Image Compression = 80

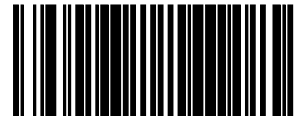

Image Compression = 90



★ Image Compression = 100





## Region of Interest (ROI)

This feature specifies the X-Y coordinates for the Region of Interest (ROI). The region of interest coordinates are defined as follows:

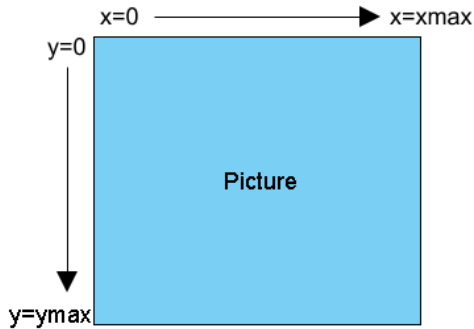

Where **xmax** is the x-size of a full size image (1279 pixels), and **ymin** is the y-size of a full size image (1023 pixels).

For example, a coordinate set of 0, 639, 512, 1023 will produce the bottom left section of a full size image.



**NOTE: Picture coordinates are NOT defined on a Cartesian coordinate plane.**

- Byte [0]-[1]: 16 bit hex value xmin
- Byte [2]-[3]: 16 bit hex value xmax
- Byte [4]-[5]: 16 bit hex value ymin
- Byte [6]-[7]: 16 bit hex value ymax



**NOTE: If the xmax/ymax values are configured larger than the maximum values above, they will default to 1 less than their respective maximum values.**

**If the xmin/ymin values are configured larger than xmax/ymax, they will default to 0.**

**Images extracted with ROI must be in JPG format.**

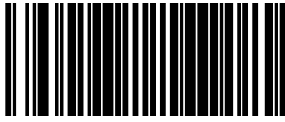

## Region of Interest (continued)



★ Region of Interest = default



Region of Interest = upper left quadrant



Region of Interest = upper right quadrant



Region of Interest = lower left quadrant



Region of Interest = lower right quadrant

# INTERFACE RELATED FEATURES

SECTION CONTENTS	
<b>INTERFACE SELECTION</b> starting on page 50	
<ul style="list-style-type: none"> <li>•USB-COM Interface Setup</li> <li>•RS-232 Interface Selection</li> </ul>	<ul style="list-style-type: none"> <li>•USB Interface Selection</li> <li>•Keyboard Interface Selection</li> </ul>
<b>INTERFACE FEATURES</b> starting on page 53	
<ul style="list-style-type: none"> <li>•Maximum Host-Transmitted Message Length</li> </ul>	
<b>RS-232 INTERFACE FEATURES</b> starting on page 54	
<ul style="list-style-type: none"> <li>•RS-232 Baud Rate</li> <li>•RS-232 Number of Data Bits</li> <li>•RS-232 Number of Stop Bits</li> <li>•RS-232 Parity</li> <li>•RS-232 Hardware Control</li> <li>•RS-232 Intercharacter Delay</li> <li>•RS-232 Software Flow Control</li> <li>•RS-232 Beep on ASCII BEL</li> </ul>	<ul style="list-style-type: none"> <li>•Beep on Not on File</li> <li>•RS-232 ACK NAK Features                             <ul style="list-style-type: none"> <li>- ACK NAK Enable</li> <li>- RS-232 ACK Character</li> <li>- RS-232 NAK Character</li> <li>- RS-232 Retry on ACK NAK Timeout</li> <li>- RS-232 ACK NAK Timeout Value</li> <li>- RS-232 ACK NAK Retry Count</li> <li>- RS-232 ACK NAK Error Handling</li> </ul> </li> <li>•RS-232 Indicate Transmission Failure</li> <li>•RS-232 Ignore Host Commands</li> </ul>
<b>USB-OEM INTERFACE FEATURES</b> starting on page 68	
<ul style="list-style-type: none"> <li>•USB OEM Scanner Device Type</li> </ul>	
<b>USB KEYBOARD FEATURES</b> starting on page 70	
<ul style="list-style-type: none"> <li>•Keyboard Layout</li> <li>•USB Keyboard Country Mode</li> <li>•USB Keyboard Caps Lock State</li> <li>•No Keyboard Support</li> </ul>	<ul style="list-style-type: none"> <li>•USB Keyboard Send Control Characters</li> <li>•Quiet Interval</li> <li>•USB Keyboard Intercharacter Delay</li> <li>•USB Keyboard Additional Interface Options</li> </ul>

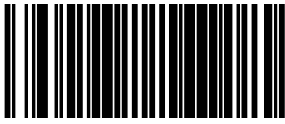

## INTERFACE SELECTION

### INTERFACE TYPE

Specifies the current scanner interface.



**NOTE:** The correct interface cable is generally included for the reader interface type you ordered.



**NOTE:** If the scanner's interface type must be changed, always be sure that interface configuration is the **FIRST** item scanned during a programming session. (Selecting an interface type resets **ALL** other configuration items to the factory default for that interface type.)



**CAUTION:** Great care should be taken to select the correct interface type, since you can cause damage to the scanner and/or POS terminal by attempting to change to an incompatible interface. **ALWAYS** make interface selections with the host cable **DISCONNECTED**.



**NOTE:** When an interface is selected, the scanner loads the configuration for that interface as the selection is made. Any custom configurations done in the previous interface will not be carried over to the configuration for the new interface.

### USB-COM Interface Setup

Before plugging your scanner into the Host PC, please ensure you have already copied the executable DLS USB-COM driver file to your PC and that the scanner's interface is set to USB COM. The DLS USB-COM driver (for Windows operating systems) is provided by Datalogic or downloaded from the Datalogic website.

1. Execute the DLS USB-COM driver file.
2. When the scanner is first plugged into the PC, Windows will bring up the "Found New Hardware" message.
3. The installation is complete.



**NOTE:** Contact your Datalogic Representative for information about USB-COM operation with other major PC operating systems.

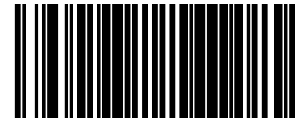

## RS-232 Interface Selection

Remember to cover any unused bar codes on this and the facing page to ensure that the scanner reads only the bar code you intend to scan.



**CAUTION: Great care should be taken to select the correct interface type, since you can cause damage to the scanner and/or POS terminal by attempting to change to an incompatible interface. ALWAYS make interface selections with the host cable DISCONNECTED.**



Interface Type = RS-232 Standard



Interface Type = RS-232 Wincor-Nixdorf

## USB Interface Selection

Remember to cover any unused bar codes on this and the facing page to ensure that the scanner reads only the bar code you intend to scan.



**CAUTION: Great care should be taken to select the correct interface type, since you can cause damage to the scanner and/or POS terminal by attempting to change to an incompatible interface. ALWAYS make interface selections with the host cable DISCONNECTED.**



Interface Type = USB OEM



Interface Type = USB TEC



Interface Type = USB COM

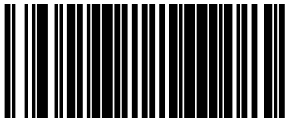

## Keyboard Interface Selection

Remember to cover any unused bar codes on this and the facing page to ensure that the scanner reads only the bar code you intend to scan.



**CAUTION: Great care should be taken to select the correct interface type, since you can cause damage to the scanner and/or POS terminal by attempting to change to an incompatible interface. ALWAYS make interface selections with the host cable DISCONNECTED.**



Interface Type = USB Keyboard

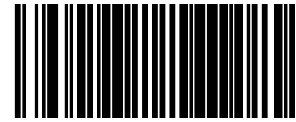

## INTERFACE FEATURES

### Maximum Host-Transmitted Message Length

Specifies the maximum number of data characters allowed in messages transmitted to the host.

To set the Maximum Host-Transmitted Message Length:

1. Scan the Enter/Exit Programming Mode bar code.
2. Scan the bar code, [Set Maximum Host-Transmitted Message Length](#) below. You'll need to cover any unused bar codes on this and the facing page to ensure that the scanner reads only the bar code you intend to scan.
3. Scan the appropriate digits from the [Keypad on page 461](#) in [Appendix C](#) that represent the desired maximum host-transmitted message length. The selectable range is 0-249 data characters. (Labels that are longer than this length are not read.) Pad all single and double digit numbers with leading zeroes to yield a three-digit entry (000-249).



**NOTE: If this configuration item is set to 0 (000), there is no general length limit imposed on data being transmitted to the host.**

4. The scanner will automatically exit Programming Mode when the appropriate amount of digits have been scanned.

Default setting for this feature is:

★ 000 - No general limit imposed

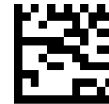

Set Maximum Host-Transmitted Message Length

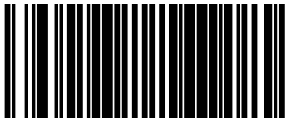

## RS-232 INTERFACE FEATURES



**NOTE: A setting of no parity with 7 data bits is invalid and will default to 8 data bits and no parity.**

### RS-232 Baud Rate



RS-232 Baud Rate = 1200



RS-232 Baud Rate = 2400



RS-232 Baud Rate = 4800



★ RS-232 Baud Rate = 9600



RS-232 Baud Rate = 19200



RS-232 Baud Rate = 38400



RS-232 Baud Rate = 57600



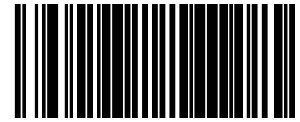

## RS-232 Baud Rate (continued)



RS-232 Baud Rate = 115200



RS-232 Baud Rate = 230400

## RS-232 Number of Data Bits

Specifies number of data bits required for sending and receiving data.



**NOTE: A setting of 7 data bits with no parity will default to 8 data bits and no parity.**



RS-232 Number of Data Bits = 7



★RS-232 Number of Data Bits = 8

## RS-232 Number of Stop Bits

Specifies number of stop bits required for sending and receiving data



★RS-232 Number of Stop Bits = 1



RS-232 Number of Stop Bits = 2

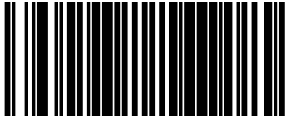

## RS-232 Parity

Specifies parity required for sending and receiving data.

Options for this setting are:

- RS-232 PARITY = NONE
- RS-232 PARITY = EVEN
- RS-232 PARITY = ODD.



**NOTE: A setting of no parity with 7 data bits will default to 8 data bits and no parity.**



★ RS-232 Parity = None



RS-232 Parity = Even



RS-232 Parity = Odd

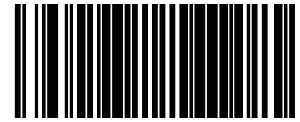

## RS-232 Hardware Control

Enables/disables use of the RS-232 CTS signal for flow control and/or scan control.

Options are:

- Disable — The scanner transmits to the host regardless of any activity on the CTS line.
- Enable CTS Flow Control — The CTS signal controls transmission of data to the host.
- Enable CTS Scan Control — The CTS line must be active for scanner to read and transmit data. While the CTS line is inactive, scanner remains in a host- disabled state; following a successful label transmission, the CTS signal must transition to inactive and then to active to enable scanning for the next label.
- Enable Magellan SL CTS Scan Control — Follows the same hardware protocol as older Magellan SL scanners.



★ RS-232 Hardware Control = Disable



RS-232 Hardware Control = Enable CTS Flow Control



RS-232 Parity = Enable CTS Scan Control



RS-232 Hardware Control = Enable MGL SL CTS Scan  
Control

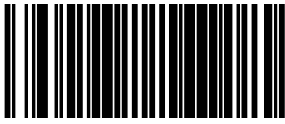

## RS-232 Intercharacter Delay

Specifies delay between the end of one character and the beginning of the next in 10-millisecond increments. This delay is inserted after each data character transmitted. If the transmission speed is too high, the system may not be able to receive all characters. You may need to adjust the delay to make the system work properly.

To set the RS-232 Intercharacter Delay:

1. Scan the Enter/Exit Programming Mode bar code.
2. Scan the bar code below, [Set RS-232 Intercharacter Delay](#).
3. Scan the appropriate digits from the [Alpha-Numeric Keypad in Appendix C](#) that represent the desired delay. The selectable range is 0-100, which is the delay in 10-millisecond increments. Pad all single and double digit numbers with leading zeroes to yield a three-digit entry (000-100).

Examples:

001 = 10ms

005 = 50ms

040 = 400ms

100 = 1,000ms (1 second)

4. The scanner will automatically exit Programming Mode when the appropriate amount of digits have been scanned.

Default setting for this feature is:

★ 00 - No Intercharacter Delay



Set RS-232 Intercharacter Delay

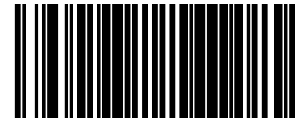

## RS-232 Software Flow Control

Enables/disables RS-232 Flow Control using XON/ XOFF characters.



**NOTE: This item will be ignored when the feature, RS-232 NAK Character, is enabled**

To set this feature:

1. Scan the Enter/Exit Programming Mode bar code.
2. Scan either the enable or disable bar code below. You'll need to cover any unused bar codes on this and the facing page to ensure that the scanner reads only the bar code you intend to scan.
3. Complete the programming sequence by scanning the Enter/Exit Programming Mode bar code.



★RS-232 Software Flow Control= Disable

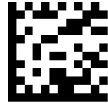

RS-232 Software Flow Control= Enable

## RS-232 Beep on ASCII BEL

Enables/disables ability of scanner to beep (sound a good read tone) on receiving an ASCII BEL (07 hex).



★RS-232 Beep on ASCII BEL = Disable



RS-232 Beep on ASCII BEL = Enable

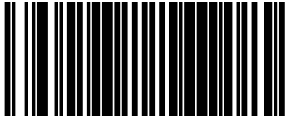

## Beep on Not on File

Select for the host to beep (or not) when a not-on-file condition is detected by the host.



RS-232 Beep on Not on File = Muted



★ RS-232 Beep on Not on File = Low Volume



RS-232 Beep on Not on File = Medium Volume



RS-232 Beep on Not on File = High Volume

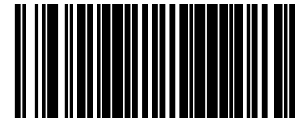

## RS-232 ACK NAK Features

### ACK NAK Enable

This enables/disables the ability of the scanner to support the RS-232 ACK/NAK protocol. When configured, the scanner and/or host sends an “ACK” when it receives data properly, and sends “NAK” when the data is in error. Selections for this option are:

- Disable ACK NAK
- Enable for Label Transmission — the scanner expects an ACK/NAK response from the host when a label is sent)
- Enable for Host Acknowledgement — Enabled for Host Commands (the scanner will respond with ACK/NAK when the host sends a command)
- Enable for Label & Host — Enabled for both Label Transmission & Host Command acknowledgement.

To select the option for RS-232 ACK NAK Enable:

1. Scan the Enter/Exit Programming Mode bar code.
2. Scan the desired option from bar codes below and on the following page. You’ll need to cover any unused bar codes on this and the facing page to ensure that the scanner reads only the bar code you intend to scan.
3. Complete the programming sequence by scanning the Enter/Exit Programming Mode bar code.



★ RS-232 ACK NAK = Disable



RS-232 ACK NAK = Enable for Label Transmission



RS-232 ACK NAK = Enable for Host Acknowledgement



RS-232 ACK NAK = Enable for Label & Host

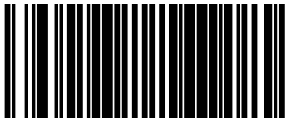

## RS-232 ACK Character

This feature specifies which ASCII character will be used as an ACK character.



**NOTE: DO NOT set this feature to use previously defined characters such as XON, XOFF or host commands as this will conflict with normal operation of these characters. 8-bit data is not recognized when the feature, RS-232 Number of Data Bits, is set to 7 data bits.**

To specify the RS-232 ACK Character:

1. Scan the Enter/Exit Programming Mode bar code.
2. Scan the bar code, SET RS-232 ACK Character below. You'll need to cover any unused bar codes on this and the facing page to ensure the scanner reads only the bar code you intend to scan.
3. Scan the appropriate digits from the [Alpha-Numeric Keypad in Appendix C](#) that represent the hex designation for the desired character. A table containing the ASCII Character Set and their corresponding Hex Values is available in the inside back cover of this manual. ASCII parameters must be input by scanning a pair of hexadecimal digits for the desired character. For example, if ASCII "A" were the desired ACK character, you would scan the digits "4", then "1" (the ASCII corresponding hex value).
4. The scanner will automatically exit Programming Mode when the appropriate amount of digits/characters have been scanned.

Default setting for this feature is:

★06



Set RS-232 ACK Character



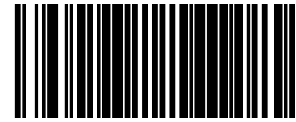

## RS-232 NAK Character

This feature specifies which ASCII character will be used as a NAK character.



**NOTE: DO NOT set this feature to use previously defined characters such as XON, XOFF or host commands as this will conflict with normal operation of these characters. 8-bit data is not recognized when the feature, RS-232 Number of Data Bits, is set to 7 data bits.**

To specify the RS-232 NAK Character:

1. Scan the Enter/Exit Programming Mode bar code.
2. Scan the bar code, SET RS-232 NAK Character below. You'll need to cover any unused bar codes on this and the facing page to ensure the scanner reads only the bar code you intend to scan.
3. Scan the appropriate digits from the [Alpha-Numeric Keypad in Appendix C](#) that represent the hex designation for the desired character. A table containing the ASCII Character Set and their corresponding Hex Values is available in the inside back cover of this manual. ASCII parameters must be input by scanning a pair of hexadecimal digits for the desired character. For example, if ASCII "A" were the desired NAK character, you would scan the digits "4", then "1" (the ASCII corresponding hex value).
4. The scanner will automatically exit Programming Mode when the appropriate amount of digits/characters have been scanned.

Default setting for this feature is:

★15



Set RS-232 NAK Character

## RS-232 Retry on ACK NAK Timeout

This option specifies the action scanner performs on expiration of the RS-232 ACK NAK Timeout Value.



RS-232 Retry on ACK NAK Timeout = Disable



★RS-232 Retry on ACK NAK Timeout = Enable

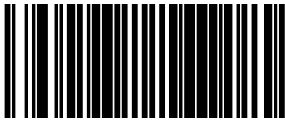

## RS-232 ACK NAK Timeout Value

This item specifies the time the scanner will wait for an ACK character from the host following a label transmission.

- 0 = Infinite timeout
- 1 - 75 = Timeout in 200-millisecond increments

To set the ACK NAK Timeout Value:

1. Scan the Enter/Exit Programming Mode bar code.
2. Scan the bar code below, [Set RS-232 ACK NAK Timeout Value](#). You'll need to cover any unused bar codes on this and the facing page to ensure that the scanner reads only the bar code you intend to scan.
3. Scan the appropriate digits from the [Alpha-Numeric Keypad in Appendix C](#) that represent the desired timeout. A setting of 0 specifies an infinite timeout. The remaining selectable range is 1-75, which is the timeout in 200-millisecond increments. Pad all single digit numbers with a leading zero to yield a two-digit entry (00-75).

Examples:

00 = Infinite timeout

01 = 200ms

05 = 1,000ms (1 second)

40 = 8,000ms (8 seconds)

75 = 15,000ms (15 seconds)

The scanner will automatically exit Programming Mode when the appropriate amount of digits have been scanned.

Default setting for this feature is:

★ 01 - 200ms



Set RS-232 ACK NAK Timeout Value

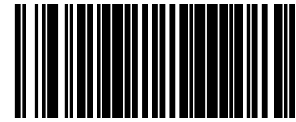

## RS-232 ACK NAK Retry Count

This feature sets the number of times for the scanner to retry a label transmission under a retry condition.

To set the RS-232 ACK NAK Retry Count:

1. Scan the Enter/Exit Programming Mode bar code.
2. Scan the bar code, [Set RS-232 ACK NAK Retry Count](#) below. You'll need to cover any unused bar codes on this and the facing page to ensure that the scanner reads only the bar code you intend to scan.
3. Scan the appropriate digits from the [Alpha-Numeric Keypad in Appendix C](#) that represent the desired number. The selectable range is 000-255 resets. Pad all single and double digit numbers with leading zeroes to yield a three-digit entry (000-255).



**NOTE: A setting of 255 specifies "retry forever."**

4. The scanner will automatically exit Programming Mode when the appropriate amount of digits have been scanned.

Default setting for this feature is:

★003 - Three retrys



Set RS-232 ACK NAK Retry Count

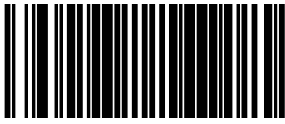

## RS-232 ACK NAK Error Handling

This item specifies the method the scanner will use to handle errors detected while waiting to receive the ACK character from the host. Errors include unrecognized host commands and communication errors such as parity or framing errors.

- Ignore Errors (recommended setting)
- Assume ACK (risk of lost label data)
- Assume NAK (risk of duplicate label)



★ RS-232 ACK NAK Error Handling = Ignore Errors



RS-232 ACK NAK Error Handling = Assume ACK

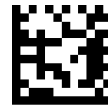

RS-232 ACK NAK Error Handling = Assume NAK

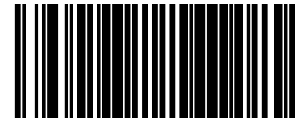

## RS-232 Indicate Transmission Failure

This feature enables / disables the ability of the scanner to sound a bad label beep indication when a transmission failure occurs.

To set this feature:

1. Scan the Enter/Exit Programming Mode bar code.
2. Scan the desired option from the bar codes below. You'll need to cover any unused bar codes on this and the facing page to ensure that the scanner reads only the bar code you intend to scan.
3. Complete the programming sequence by scanning the Enter/Exit Programming Mode bar code.



RS-232 Indicate Transmission Failure = Disable



★RS-232 Indicate Transmission Failure = Enable

## RS-232 Ignore Host Commands

When set to ignore host commands, the scanner will ignore all host commands except the minimum set necessary to keep the interface active and transmit labels. For normal operation of the interface, select Obey Host Commands.



★RS-232 Ignore Host Commands = Don't Ignore



RS-232 Ignore Host Commands = Ignore

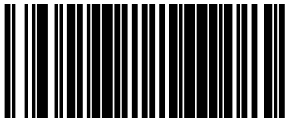

## USB-OEM INTERFACE FEATURES

### USB OEM Scanner Device Type

The OEM-USB protocol allows for the scanner to be identified as one of two different types of bar code scanners. Depending on what other scanners you may already have connected to a USB POS, you may need to change this setting to enable all scanners to communicate. Options are:

- Table Top Scanner
- Handheld Scanner

To set this feature:

1. Scan the Enter/Exit Programming Mode bar code.
2. Scan your selection from the bar codes below. You'll need to cover any unused bar codes on this and the facing page to ensure that the scanner reads only the bar code you intend to scan.
3. Complete the programming sequence by scanning the Enter/Exit Programming Mode bar code.



★ USB OEM Scanner Device Type = Table Top Scanner



USB OEM Scanner Device Type = Handheld Scanner

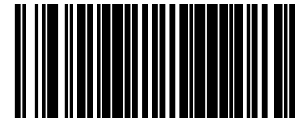

## USB OEM Additional Interface Options

To set this feature:

1. Scan the Enter/Exit Programming Mode bar code.
2. Scan your selection from the bar codes below. You'll need to cover any unused bar codes on this and the facing page to ensure that the scanner reads only the bar code you intend to scan.

Complete the programming sequence by scanning the Enter/Exit Programming Mode bar code



USB OEM Interfaces Option2 =  
Enable scanner at first enumeration after BusReset



★ USB OEM Interfaces Option2 =  
Disable scanner at first enumeration after BusReset

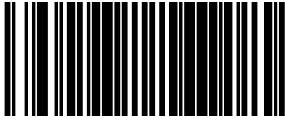

## USB KEYBOARD FEATURES

As a keyboard interface, the scanner supports most popular PC terminals.

### Keyboard Layout

The Keyboard Layout option supports many countries. For details about Keyboard Layout, please refer to your operating system manual.

### USB Keyboard Country Mode

This feature specifies the country/language that will be supported by the keyboard.



★ USB Keyboard Country Mode = USA



USB Keyboard Country Mode = Belgium



USB Keyboard Country Mode = Britain



USB Keyboard Country Mode = Denmark



USB Keyboard Country Mode = France



USB Keyboard Country Mode = Germany



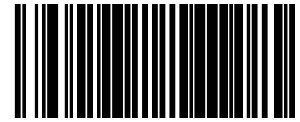

## USB Keyboard Country Mode (continued)



USB Keyboard Country Mode = Italy



USB Keyboard Country Mode =  
Norway



USB Keyboard Country Mode =  
Portugal



USB Keyboard Country Mode = Spain



USB Keyboard Country Mode =  
Sweden



USB Keyboard Country Mode =  
Switzerland



USB Keyboard Country Mode =  
Japanese 106-key

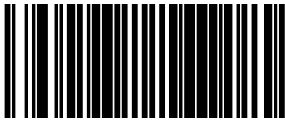

## USB Keyboard Country Mode (continued)



USB Keyboard Country Mode = Hungary



USB Keyboard Country Mode =  
Czech Republic



USB Keyboard Country Mode = Slovakia



USB Keyboard Country Mode =  
Romania



USB Keyboard Country Mode =  
Croatia



USB Keyboard Country Mode = Poland



USB Keyboard Country Mode =  
French Canadian



USB Keyboard Country Mode = Turkish

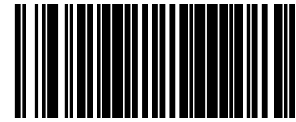

## USB Keyboard Caps Lock State

This feature specifies the format in which the scanner sends character data. Selections are:

**Caps Lock OFF:** Send character data in normal format

**Caps Lock ON:** Send character data in reverse case

**Shift Lock Mode:** This setting results in a Caps Lock OFF functionality.

**Caps Lock Compensation Mode:** This only applies to USB Keyboard. For other interfaces, this setting results in a Caps Lock OFF functionality.

To set this feature:

1. Scan the Enter/Exit Programming Mode bar code.
2. Scan the desired selection from the bar codes below. You'll need to cover any unused bar codes on this and the facing page to ensure that the scanner reads only the bar code you intend to scan.
3. Complete the programming sequence by scanning the Enter/Exit Programming Mode bar code.



★ USB Keyboard Caps Lock State =  
Caps Lock OFF



USB Keyboard Caps Lock State =  
Caps Lock ON



USB Keyboard Caps Lock State =  
Shift Lock Mode



USB Keyboard Caps Lock State =  
Caps Lock Compensation

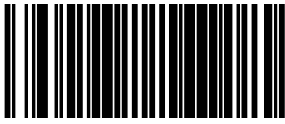

## No Keyboard Support

Enables the scanner to perform host communications normally performed by an attached keyboard.

To set this feature:

1. Scan the Enter/Exit Programming Mode bar code.
2. Scan either the enable or disable bar code below. You'll need to cover any unused bar codes on this and the facing page to ensure that the scanner reads only the bar code you intend to scan.
3. Complete the programming sequence by scanning the Enter/Exit Programming Mode bar code.



★ No Keyboard Support = Disable



No Keyboard Support = Enable

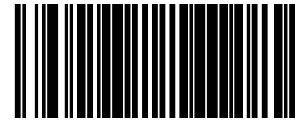

## USB Keyboard Send Control Characters

This feature specifies how the scanner transmits ASCII control characters to the host.



**NOTE: Affects suffix and prefix characters. When disabled, only ASCII characters between 20H and 127H inclusive (space... delete) plus special characters 0DH (carriage return), 08H (backspace), 27H (ESC), 09H (right tab) and 0BH (left tab) are transmitted.**

Choices are:

**Disable:** No control characters are sent to the host.

**Enable transmission of control characters to host:** Control characters are sent to the host.

**Send characters between 00H and 1FH:** Send characters between 00H and 1FH according to special function-key mapping table (This is used to send keys that are not in normal ASCII set; a unique set is provided for each available scancode set).

To set this feature:

1. Scan the Enter/Exit Programming Mode bar code.
2. Scan the bar code for the desired setting below. You'll need to cover any unused bar codes on this and the facing page to ensure that the scanner reads only the bar code you intend to scan.
3. Complete the programming sequence by scanning the Enter/Exit Programming Mode bar code.



★ Keyboard Send Control Characters = Disable



Keyboard Send Control Characters =  
Enable transmission of control characters to host



USB Keyboard No Keyboard Support =  
Send characters between 00H and 1FH

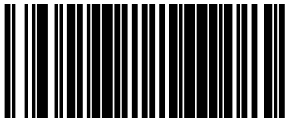

## Quiet Interval

This setting specifies the amount of time to monitor for keyboard activity before breaking the keyboard connection.

To set this feature:

1. Scan the Enter/Exit Programming Mode bar code.
2. Scan the bar code below, [Set Quiet Interval](#). You'll need to cover any unused bar codes on this and the facing page to ensure that the scanner reads only the bar code you intend to scan.
3. Scan the appropriate digits from the [Alpha-Numeric Keypad in Appendix C](#) that represent the desired time interval. The selectable range is 001-100, which is the interval in 10-millisecond increments. Pad all single and double digit numbers with leading zeroes to yield a three-digit entry (001-100).

Examples:

001 = 10ms

005 = 50ms

040 = 400ms

100 = 1,000ms (1 second)

4. The scanner will automatically exit Programming Mode when the appropriate amount of digits have been scanned.

Default setting for this feature is:

★00A - 100ms

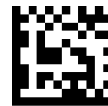

Set Quiet Interval

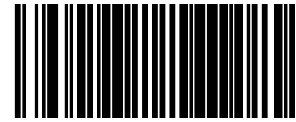

## USB Keyboard Intercharacter Delay

Specifies a time delay between characters.

To set this feature:

1. Scan the Set USB Keyboard Intercharacter Delay bar code below.
2. Scan the appropriate characters/digits from the [Alpha-Numeric Keypad in Appendix C](#) that represent the desired delay. The selectable range for this option is any decimal value from 00 (no delay) to 99 in 10 ms increments. A table containing the ASCII Character Set and their corresponding decimal values is available in the inside back cover of this manual. ASCII parameters must be input by scanning decimal digits for each character. Pad all single digit numbers with leading zero to yield a two-digit entry (00-99). Thus, to set an intercharacter delay of 70ms, bar codes containing the digits '0' and '7' must be scanned.
3. Complete the programming sequence by scanning the Enter/Exit Programming Mode bar code.

★ Default setting for this feature is: 01 (10ms)



Set USB Keyboard Intercharacter Delay

## USB Keyboard Additional Interface Options

See "[Keyboard Function Key Mappings](#)" on page 273 for more information.

To set this feature:

1. Scan the Enter/Exit Programming Mode bar code.
2. Scan your selection from the bar codes below. You'll need to cover any unused bar codes on this and the facing page to ensure that the scanner reads only the bar code you intend to scan.
3. Complete the programming sequence by scanning the Enter/Exit Programming Mode bar code.



USB Keyboard Interface Option 1 =  
Use Rev C function table



★ USB Keyboard Interfaces Option 2 =  
Use Rev D function table

# DATA EDITING

SECTION CONTENTS
<b>DATA EDITING OVERVIEW</b> starting on page 79
<b>GLOBAL PREFIX/SUFFIX</b> starting on page 80 <ul style="list-style-type: none"><li>• Global Prefix</li><li>• Global Suffix</li></ul>
<b>AIM ID</b> starting on page 82
<b>LABEL ID</b> starting on page 83 <ul style="list-style-type: none"><li>• Label ID Control</li><li>• Setting Label ID</li><li>• 1D Symbologies on page 97</li><li>• 2D Symbologies on page 102</li></ul>
<b>CASE CONVERSION</b> starting on page 91
<b>CHARACTER CONVERSION</b> starting on page 92



## DATA EDITING OVERVIEW

When a bar code is scanned, additional information can be sent to the host computer along with the bar code data. This combination of bar code data and supplementary user-defined data is called a “message string.” The features in this chapter can be used to build specific user-defined data into a message string.

There are several types of selectable data characters that can be sent before and after scanned data. You can specify if they should be sent with all symbologies, or only with specific symbologies. Figure 8 shows the available elements you can add to a message string:

**Figure 8. Breakdown of a Message String**

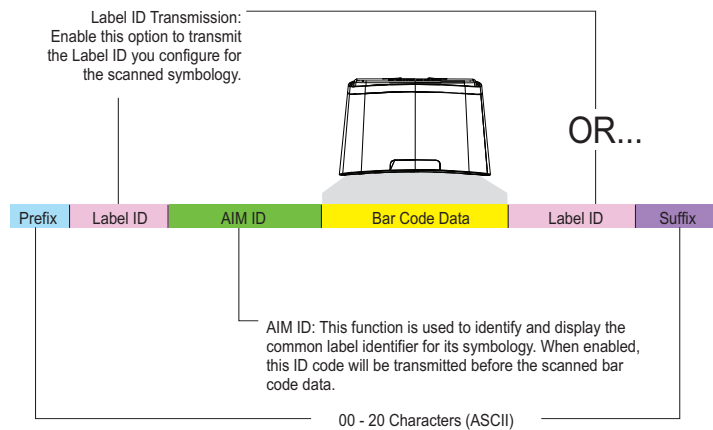

### Please Keep In Mind...

- Modifying a message string is not a mandatory requirement. Data editing is a sophisticated feature allowing highly customizable output for advanced users. Factory default settings for data editing is typically set to NONE.
- A prefix or suffix may be applied (reference the [1D Symbologies](#) chapter for these settings) or across all symbologies (set via the Global features in this chapter).
- You can add any character from the [ASCII Character Set](#) (from 00-FF) on the inside back cover of this manual as a prefix, suffix or Label ID.
- Enter prefixes and suffixes in the order in which you want them to appear on the output.

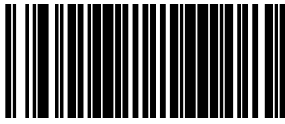

## GLOBAL PREFIX/SUFFIX

### Global Prefix

This feature applies to RS-232 interfaces (Standard, Wincor-Nixdorf). It specifies the prefix that is added to beginning of label transmission.

To specify the Global Prefix Character(s):

1. Scan the Enter/Exit Programming Mode bar code.
2. Scan the bar code Set Global Prefix below. Cover any unused bar codes to ensure the scanner reads only the bar code you intend to scan.
3. Scan the appropriate characters/digits from the [Alpha-Numeric Keypad](#) that represent the hex designation for the desired character(s). The ASCII Character Set and their corresponding Hex Values are available in the inside back cover of this manual. ASCII parameters must be input by scanning a pair of hexadecimal digits for each character. Thus, to set a two-character value of AB, bar codes containing the digits '4', '1', '4', and '2' must be scanned. The selectable range for this option is any hex value from 00 to FF. Up to 20 hex pairs can be designated.



**NOTE: To specify "No Global Prefix," scan 00.**

4. If designating the full 20 hex pairs, the scanner will exit Programming Mode when the appropriate amount of digits have been scanned. If designating less than 20 hex pairs, you can end the programming sequence early by scanning the Terminate Sequence bar code.
5. Complete the programming sequence by scanning the Enter/Exit Programming Mode bar code.

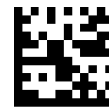

Set Global Prefix



Terminate Sequence

Default setting for this feature is:

★ 00 - No Global Prefix

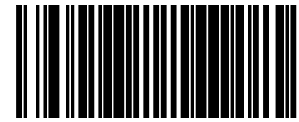

## Global Suffix

This feature applies to RS-232 interfaces (Standard, Wincor-Nixdorf). It specifies the suffix that is added to end of a label transmission. Three standard options are available below. Contact your dealer for other alternate settings for this feature.

- No Global Suffix
- CR — Carriage Return
- CR LF — Carriage Return, Line Feed

To set the Global Suffix:

1. Scan the Enter/Exit Programming Mode bar code.
2. Scan your selection from the bar codes below.
3. Complete the programming sequence by scanning the Enter/Exit Programming Mode bar code.



Global Suffix = No Global Suffix



★ Global Suffix = CR



Global Suffix = CR LF



# AIM ID

AIM (Automatic Identification Manufacturers) label identifiers are assigned from a globally standardized list — as opposed to custom label ID characters you select yourself — and can be included with scanned bar code data. AIM label identifiers consist of three characters as follows:

- A close brace character (ASCII '['), followed by...
- A code character (see the table below), followed by...
- A modifier character (the modifier character is symbol dependent)

SYMBOLGY	CHAR	SYMBOLGY	CHAR
UPC/EAN	E	<small>Code 128/EAN 128</small>	C
Code 39	A	GS1 Omnidirectional, GS1 Expanded	e
Codabar	F	Standard 2 of 5	S
Interleaved 2 of 5	I	ISBN	X <sup>a</sup>
<small>Code 93</small>	G		

a. ISBN (X with a 0 modifier character)

Figure 9. AIM ID

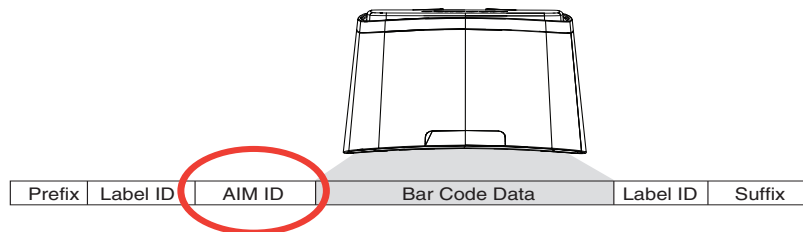

★ Global AIM ID = Disable



Global AIM ID = Enable

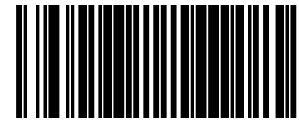

## LABEL ID

### Label ID Control

This feature specifies whether or not Label IDs are transmitted to the host and if so, whether to attach them as a prefix or suffix.

Choices are:

- Disable
- Enable as a Prefix
- Enable as a Suffix

To select the option for Label ID Control:

1. Scan the Enter/Exit Programming Mode bar code.
2. Scan the desired option from the bar codes below. You'll need to cover any unused bar codes on this and the facing page to ensure that the scanner reads only the bar code you intend to scan.
3. Complete the programming sequence by scanning the Enter/Exit Programming Mode bar code.



Label ID Control = Disable

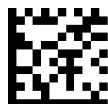

★ Label ID Control = Enable as a Prefix



Label ID Control = Enable as a Suffix



## Setting Label ID





This feature allows the setting of custom Label ID character(s) for each available symbology type if other than the default Label ID is desired.

To set this feature:

1. Scan the Enter/Exit Programming Mode bar code.
2. Scan the bar code for the desired symbology below. You'll need to cover any unused bar codes on this and the facing page to ensure the scanner reads only the bar code you intend to scan.
3. Scan the appropriate digits from the [Alpha-Numeric Keypad](#) that represent the desired Label ID characters; entered as two hex pairs. A table containing the ASCII Character Set and their corresponding Hex Values is available in the inside back cover of this manual. ASCII parameters must be input by scanning a pair of hexadecimal digits for each character. Thus, to set a two-character value of AB, bar codes containing the digits '4', '1', '4', and '2' must be scanned. The selectable range for this option is any hex value from 00 to FF.

Complete the programming sequence by scanning the Enter/Exit Programming Mode bar code.

### 1 D Symbologies

LABEL ID — 1D SYMBOLOGIES	
Default Label ID for this symbology is: 41 = A	 Set UPC-A Label ID
 Set UPC-A 2-Digit Supplemental Label ID	Default Label ID for this symbology is: 41 = A
Default Label ID for this symbology is: 41 = A	 Set UPC-A 5-Digit Supplemental Label ID
 Set UPC-E Label ID	Default Label ID for this symbology is: 45 = E
Default Label ID for this symbology is: 45 = E	 Set UPC-E 2-Digit Supplemental Label ID

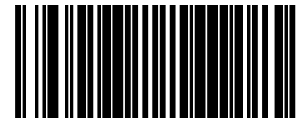

### LABEL ID — 1D SYMBOLOGIES (CONTINUED)

 <p>Set UPC-E 5-Digit Supplemental Label ID</p>	<p>Default Label ID for this symbology is: 45 = E</p>
<p>Default Label ID for this symbology is: 46 = F</p>	 <p>Set EAN-13 Label ID</p>
 <p>Set EAN-13 2-Digit Supplemental Label ID</p>	<p>Default Label ID for this symbology is: 46 = F</p>
<p>Default Label ID for this symbology is: 46 = F</p>	 <p>Set EAN-13 5-Digit Supplemental Label ID</p>
 <p>Set EAN-8 Label ID</p>	<p>Default Label ID for this symbology is: 4646 = FF</p>
<p>Default Label ID for this symbology is: 4646 = FF</p>	 <p>Set EAN-8 2-Digit Supplemental Label ID</p>
 <p>Set EAN-8 5-Digit Supplemental Label ID</p>	<p>Default Label ID for this symbology is: 4646 = FF</p>
<p>Default Label ID for this symbology is: 47 = G</p>	 <p>Set GTIN Label ID</p>

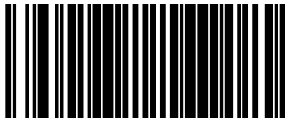

### LABEL ID — 1D SYMBOLOGIES (CONTINUED)

 <p>Set GTIN 2-Digit Supplemental Label ID</p>	<p>Default Label ID for this symbology is: 4732 = G2</p>
<p>Default Label ID for this symbology is: 4735 = G5</p>	 <p>Set GTIN 5-Digit Supplemental Label ID</p>
 <p>Set GTIN Code 128 Supplemental Label ID</p>	<p>Default Label ID for this symbology is: 4738 = G8</p>
<p>Default Label ID for this symbology is: 5234 = R4</p>	 <p>Set DataBar Omnidirectional Label ID</p>
 <p>Set DataBar Omnidirectional Composite Label ID</p>	<p>Default Label ID for this symbology is: 5234 = R4</p>
<p>Default Label ID for this symbology is: 5258 = RX</p>	 <p>Set DataBar Limited Label ID</p>
 <p>DataBar Expanded Label ID</p>	<p>Default Label ID for this symbology is: 5258 = RX</p>
<p>Default Label ID for this symbology is: 5258 = RX</p>	 <p>DataBar Expanded Composite Label ID</p>



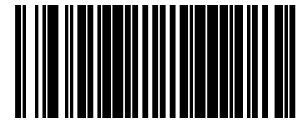

### LABEL ID — 1D SYMBOLOGIES (CONTINUED)

 <p>Set DataBar Limited Composite Label ID</p>	<p>Default Label ID for this symbology is: 5258 = RX</p>
<p>Default Label ID for this symbology is: 2A = *</p>	 <p>Code 39 Label ID</p>
 <p>Code 32 Label ID</p>	<p>Default Label ID for this symbology is: 41 = A</p>
<p>Default Label ID for this symbology is: 23 = #</p>	 <p>Code 128 Label ID</p>
 <p>EAN 128 Label ID</p>	<p>Default Label ID for this symbology is: 50 = P</p>
<p>Default Label ID for this symbology is: 69 = i</p>	 <p>I 2 of 5 Label ID</p>
 <p>Codabar Label ID</p>	<p>Default Label ID for this symbology is: 25 = %</p>
<p>Default Label ID for this symbology is: 26 = &amp;</p>	 <p>Code 93 Label ID</p>

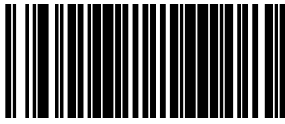

### LABEL ID — 1D SYMBOLOGIES (CONTINUED)

	Default Label ID for this symbology is: 40 = @
MSI Label ID	
Default Label ID for this symbology is: 73 = s	Standard 2 of 5 Label ID
	Default Label ID for this symbology is: 49 = l
ISBN Label ID	
Default Label ID for this symbology is: 446D = Dm	Data Matrix Label ID
	Default Label ID for this symbology is: 50 = P
PDF 417 Label ID	
Default Label ID for this symbology is: 6D50 = mP	Micro PDF 417 Label ID
	Default Label ID for this symbology is: 5152 = QR
QR Code Label ID	
Default Label ID for this symbology is: 2451 = \$Q	Micro QR Code Label ID
	Default Label ID for this symbology is: 417A = Az
Aztec Label ID	

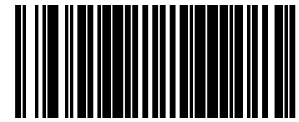

## LABEL ID — 1D SYMBOLOGIES (CONTINUED)

<p>Default Label ID for this symbology is: 4467 = Dg</p>	 <p>GS1 Datamatrix label ID</p>
 <p>GS1 QR Code label ID</p>	<p>Default Label ID for this symbology is: 5147 = QG</p>



## Global Mid-Label ID

This feature specifies a global mid-label ID that is added between two bar codes for transmission.

To set this feature:

1. Scan the Enter/Exit Programming Mode bar code.
2. Scan the [Set Global Mid-Label ID](#) bar code below. You'll need to cover any unused bar codes on this and the facing page to ensure the scanner reads only the bar code you intend to scan.
3. Scan the appropriate digits from the [Keypad on page 461](#) in [Appendix C](#) that represent the desired mid-label ID characters; entered as two hex pairs. A table containing the ASCII Character Set and their corresponding Hex Values is available in the inside back cover of this manual. ASCII parameters must be input by scanning a pair of hexadecimal digits for each character. Thus, to set a two-character value of AB, bar codes containing the digits '4', '1', '4', and '2' must be scanned. The selectable range for this option is any hex value from 00 to FF.

Complete the programming sequence by scanning the Enter/Exit Programming Mode bar code.

Default Label ID for this symbology is:

★ 00 = No Global Mid-label ID



Set Global Mid-Label ID

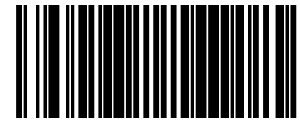

## CASE CONVERSION

This option can change the case of all alphabetic characters in scanned bar code data to upper or lower case.



**NOTE: Case conversion affects ONLY scanned bar code data, and does not affect Label ID, Prefix, Suffix, or other appended data.**

To set this feature:

1. Scan the Enter/Exit Programming Mode bar code.
2. Scan bar code for the desired option below. You'll need to cover any unused bar codes on this and the facing page to ensure that the scanner reads only the bar code you intend to scan.
3. Complete the programming sequence by scanning the Enter/Exit Programming Mode bar code.



★ Case Conversion = No Case Conversion



Case Conversion = Upper Case



Case Conversion = Lower Case



## CHARACTER CONVERSION

Character conversion is an eight byte configuration item. The eight bytes are 4 character pairs represented in hexadecimal ASCII values. The first character in the pair is the character that will be converted. The second character in the pair is the character to convert to. If the character to convert in a pair is FF, then no conversion is done.

For example, if you have the character conversion configuration item set to the following:

41423132FFFFFFFF

The first pair is 4142 or AB (41 hex is an ASCII capital A, 42 hex is an ASCII capital B) and the second pair is 3132 or 12 (31 hex is an ASCII 1, 32 is an ASCII 2). The other two pairs are FFFF and FFFF.

With the label, AG15TA81, it would look as follows after the character conversion: BG25TB82.

The A characters were converted to the B character and the 1 characters were converted to the numeral 2 character. Nothing is done with the last two character pairs, since they are all FF.

To set Character Conversion:

1. Scan the Enter/Exit Programming Mode bar code.
2. Scan the Character Conversion bar code.
3. Determine the desired string. Up to sixteen positions can be determined as in the above example. Next, turn to the ASCII Chart on the inside back cover of this manual and find the equivalent hex digits needed to fulfill the string.



**NOTE: The positions not used must be filled with the character 'F'.**

4. Turn to the [Alpha-Numeric Keypad](#) and scan the bar codes representing the hex characters determined in the previous step. When the last character is scanned, the scanner will sound a triple beep.
5. Complete the programming sequence by scanning the Enter/Exit Programming Mode bar code.

Default setting for this feature is:

★ FFFFFFFFFFFFFFFFFF (No Character Conversion)



Set Character Conversion

# 1D SYMBOLOGY PROGRAMMING

## 1D Symbologies



**NOTE:** If the scanner's interface type must be changed, always be sure that interface configuration is the **FIRST** item scanned during a programming session. (Selecting an interface type resets **ALL** other configuration items — including symbology programming — to factory default for that interface type.)

The following pages contain configuration information concerning the various bar code types (symbologies) the scanner supports.

SECTION CONTENTS	
<b>COUPON CONTROL</b> starting on page 94	<b>DATABAR EXPANDED</b> starting on page 150
<b>UPC-A</b> starting on page 96	<b>CODE 39</b> starting on page 157
<b>UPC-E</b> starting on page 101	<b>CODE 32 ITALIAN PHARMACODE</b> starting on page 169
<b>EAN-13</b> starting on page 106	<b>CODE 128</b> starting on page 172
<b>EAN-8</b> starting on page 111	<b>EAN-128</b> starting on page 181
<b>OTHER UPC/EAN OPTIONS</b> starting on page 123	<b>INTERLEAVED 2 OF 5 (I 2 OF 5)</b> starting on page 182
<b>GTIN</b> starting on page 140	<b>CODABAR</b> starting on page 191
<b>GS1 DATABAR</b> starting on page 141	<b>CODE 93</b> starting on page 203
<b>DATABAR OMNIDIRECTIONAL</b> starting on page 141	<b>MSI</b> starting on page 209
<b>DATABAR LIMITED</b> starting on page 146	<b>STANDARD 2 OF 5</b> starting on page 218

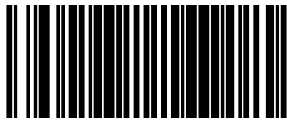

## COUPON CONTROL

### Coupon Control Enable

This feature is used to control the method of processing coupon labels. For the purposes of this feature, coupon labels are defined as:

1. UPC-A labels that start with a '5'
2. GS1 DataBar Expanded labels that start with '8110'

The options for this setting are:

- Disable — Coupon Control is turned off.
- Enable UPC-A Coupons — UPC-A coupon labels will decode but GS1 DataBar Expanded coupon labels will not. GS1 DataBar Expanded labels that are not coupon labels will decode and all UPC-A labels will decode.
- Enable GS1 DataBar Expanded Coupons — GS1 DataBar Expanded coupon labels will decode but UPC-A coupon labels will not. UPC-A labels that are not coupon labels will decode and all GS1 DataBar Expanded labels will decode.

To set this feature:

1. Scan the Enter/Exit Programming Mode bar code.
2. Scan your choice from the Coupon Control selections below. You'll need to cover any unused bar codes on this and the facing page to ensure that the scanner reads only the bar code you intend to scan.
3. Complete the programming sequence by scanning the Enter/Exit Programming Mode bar code.



Coupon Control = Disable



★ Coupon Control = Enable UPC-A Coupons



Coupon Control = Enable GS1 DataBar Expanded Coupons



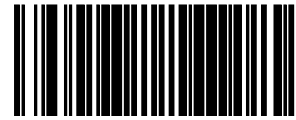

## Coupon Label Priority Timer

This feature sets the duration of the UPCA / DataBar coupon label priority timer.

To set this feature:

1. Scan the Enter/Exit Programming Mode bar code.
2. Scan your selection from the bar codes below. You'll need to cover any unused bar codes on this and the facing page to ensure that the scanner reads only the bar code you intend to scan.
3. Complete the programming sequence by scanning the Enter/Exit Programming Mode bar code.



Coupon Label Priority Timer = 0.1 Seconds



★ Coupon Label Priority Timer = 0.2 Seconds



Coupon Label Priority Timer = 0.3 Seconds



Coupon Label Priority Timer = 0.4 Seconds



Coupon Label Priority Timer = 0.5 Second



Coupon Label Priority Timer = 1 Second

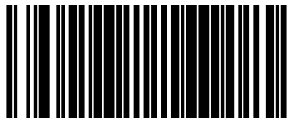

## UPC-A

### UPC-A Enable

Enables/disables the ability of the scanner to decode UPC-A labels.

To set this feature:

1. Scan the Enter/Exit Programming Mode bar code.
2. Scan either the enable or disable bar code below. You'll need to cover any unused bar codes on this and the facing page to ensure that the scanner reads only the bar code you intend to scan.
3. Complete the programming sequence by scanning the Enter/Exit Programming Mode bar code.



UPC-A = Disable



★ UPC-A = Enable

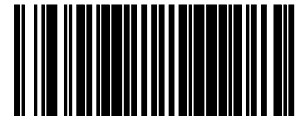

## UPC-A Number System Character Transmission

Enables/disables transmission of a UPC-A number system character.



**NOTE: This item is ignored when the advanced feature, Full Label Edit, is enabled.**

To set this feature:

1. Scan the Enter/Exit Programming Mode bar code.
2. Scan either the enable or disable bar code below. You'll need to cover any unused bar codes on this and the facing page to ensure that the scanner reads only the bar code you intend to scan.
3. Complete the programming sequence by scanning the Enter/Exit Programming Mode bar code.



UPC-A Number System Character Transmission =  
Disable



★ UPC-A Number System Character Transmission =  
Enable

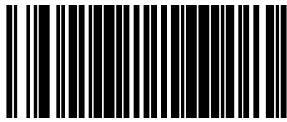

## UPC-A Check Character Transmission

Enables/disables transmission of a UPC-A check character.



**NOTE: This item is ignored when the advanced feature, Full Label Edit, is enabled.**

To set this feature:

1. Scan the Enter/Exit Programming Mode bar code.
2. Scan either the enable or disable bar code below. You'll need to cover any unused bar codes on this and the facing page to ensure that the scanner reads only the bar code you intend to scan.
3. Complete the programming sequence by scanning the Enter/Exit Programming Mode bar code.



UPC-A Check Character Transmission = Disable



★UPC-A Check Character Transmission = Enable

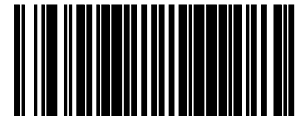

## UPC-A Minimum Read

This feature specifies the minimum number of consecutive UPC-A decodes before is accepted as good read.

To set this feature:

1. Scan the ENTER/EXIT Programming Mode bar code.
2. Scan your selection from the bar codes below. You'll need to cover any unused bar codes on this and the facing page to ensure that the scanner reads only the bar code you intend to scan.
3. Complete the programming sequence by scanning the ENTER/EXIT Programming Mode bar code.



★ UPC-A Minimum Read = 1



UPC-A Minimum Read = 2



UPC-A Minimum Read = 3



UPC-A Minimum Read = 4

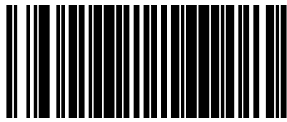

## Expand UPC-A to EAN-13

Enables/disables expansion of UPC-A labels to EAN/JAN-13.

To set this feature:

1. Scan the Enter/Exit Programming Mode bar code.
2. Scan either the enable or disable bar code below. You'll need to cover any unused bar codes on this and the facing page to ensure that the scanner reads only the bar code you intend to scan.
3. Complete the programming sequence by scanning the Enter/Exit Programming Mode bar code.

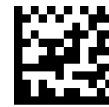

★ Expand UPC-A to EAN-13 = Disable



Expand UPC-A to EAN-13 = Enable

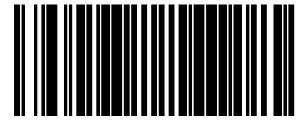

## UPC-E

### UPC-E Enable

Enables/disables the ability of the scanner to decode UPC-E labels.

To set this feature:

1. Scan the Enter/Exit Programming Mode bar code.
2. Scan either the enable or disable bar code below. You'll need to cover any unused bar codes on this and the facing page to ensure that the scanner reads only the bar code you intend to scan.
3. Complete the programming sequence by scanning the Enter/Exit Programming Mode bar code.



UPC-E = Disable



★UPC-E = Enable

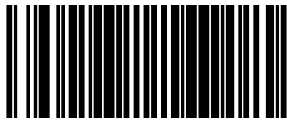

## UPC-E Number System Character Transmission

Enables/disables transmission of a UPC-E number system character.



**NOTE: This item is ignored when the advanced feature, Full Label Edit, is enabled.**

To set this feature:

1. Scan the Enter/Exit Programming Mode bar code.
2. Scan either the enable or disable bar code below. You'll need to cover any unused bar codes on this and the facing page to ensure that the scanner reads only the bar code you intend to scan.
3. Complete the programming sequence by scanning the Enter/Exit Programming Mode bar code.



UPC-E Number System Character Transmission =  
Disable



★ UPC-E Number System Character Transmission =  
Enable



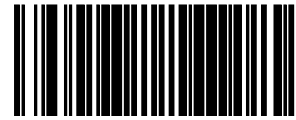

## UPC-E Check Character Transmission

Enables/disables transmission of a UPC-E check character.



**NOTE: This item is ignored when the advanced feature, Full Label Edit, is enabled.**

To set this feature:

1. Scan the Enter/Exit Programming Mode bar code.
2. Scan either the enable or disable bar code below. You'll need to cover any unused bar codes on this and the facing page to ensure that the scanner reads only the bar code you intend to scan.
3. Complete the programming sequence by scanning the Enter/Exit Programming Mode bar code.



UPC-E Check Character Transmission = Disable



★ UPC-E Check Character Transmission = Enable

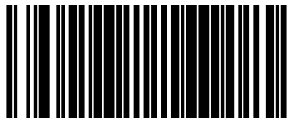

## Expand UPC-E to UPC-A

Enables/disables expansion of UPC-E labels to UPC-A.

To set this feature:

1. Scan the Enter/Exit Programming Mode bar code.
2. Scan either the enable or disable bar code below. You'll need to cover any unused bar codes on this and the facing page to ensure that the scanner reads only the bar code you intend to scan.
3. Complete the programming sequence by scanning the Enter/Exit Programming Mode bar code.



★ Expand UPC-E to UPC-A = Disable



Expand UPC-E to UPC-A = Enable

## Expand UPC-E to EAN-13

Enables/disables expansion of UPC-E labels to EAN/JAN-13.

To set this feature:

1. Scan the Enter/Exit Programming Mode bar code.
2. Scan either the enable or disable bar code below. You'll need to cover any unused bar codes on this and the facing page to ensure that the scanner reads only the bar code you intend to scan.
3. Complete the programming sequence by scanning the Enter/Exit Programming Mode bar code.



★ Expand UPC-E to EAN-13 = Disable



Expand UPC-E to EAN-13 = Enable

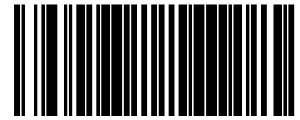

## UPC-E Minimum Read

This feature specifies the minimum number of consecutive UPC-E decodes before is accepted as good read.

To set this feature:

1. Scan the ENTER/EXIT Programming Mode bar code.
2. Scan your selection from the bar codes below. You'll need to cover any unused bar codes on this and the facing page to ensure that the scanner reads only the bar code you intend to scan.
3. Complete the programming sequence by scanning the ENTER/EXIT Programming Mode bar code.



★ UPC-E Minimum Read = 1



UPC-E Minimum Read = 2



UPC-E Minimum Read = 3



UPC-E Minimum Read = 4

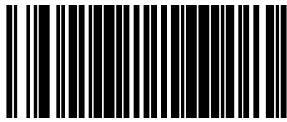

## EAN-13

### EAN-13 Enable

Enables/disables the ability of the scanner to decode EAN/JAN-13 labels.

To set this feature:

1. Scan the Enter/Exit Programming Mode bar code.
2. Scan either the enable or disable bar code below. You'll need to cover any unused bar codes on this and the facing page to ensure that the scanner reads only the bar code you intend to scan.
3. Complete the programming sequence by scanning the Enter/Exit Programming Mode bar code.



EAN-13 = Disable



★ EAN-13 = Enable

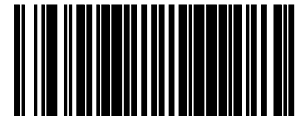

## EAN-13 First Character Transmission

Enables/disables transmission of EAN/JAN-13 first character.



**NOTE: This item is ignored when the advanced feature, Full Label Edit, is enabled.**

To set this feature:

1. Scan the Enter/Exit Programming Mode bar code.
2. Scan either the enable or disable bar code below. You'll need to cover any unused bar codes on this and the facing page to ensure that the scanner reads only the bar code you intend to scan.
3. Complete the programming sequence by scanning the Enter/Exit Programming Mode bar code.



EAN-13 First Character Transmission = Disable



★ EAN-13 First Character Transmission = Enable

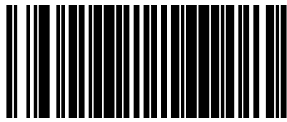

## EAN-13 Check Character Transmission

Enables/disables transmission of an EAN/JAN-13 check character.



**NOTE: This item is ignored when the advanced feature, Full Label Edit, is enabled.**

To set this feature:

1. Scan the Enter/Exit Programming Mode bar code.
2. Scan either the enable or disable bar code below. You'll need to cover any unused bar codes on this and the facing page to ensure that the scanner reads only the bar code you intend to scan.
3. Complete the programming sequence by scanning the Enter/Exit Programming Mode bar code.



EAN-13 Check Character Transmission = Disable



★ EAN-13 Check Character Transmission = Enable

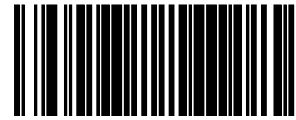

## EAN-13 ISBN Conversion Enable

Enables/disables conversion of EAN/JAN-13 labels starting with 978 to Bookland ISBN labels.

To set this feature:

1. Scan the Enter/Exit Programming Mode bar code.
2. Scan either the enable or disable bar code below. You'll need to cover any unused bar codes on this and the facing page to ensure that the scanner reads only the bar code you intend to scan.
3. Complete the programming sequence by scanning the Enter/Exit Programming Mode bar code.



★ EAN-13 ISBN Conversion = Disable



EAN-13 ISBN Conversion = Enable

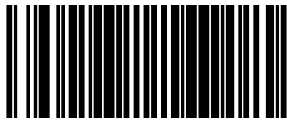

## EAN-13 Minimum Read

This feature specifies the minimum number of consecutive EAN-13 decodes before is accepted as good read.

To set this feature:

1. Scan the ENTER/EXIT Programming Mode bar code.
2. Scan your selection from the bar codes below. You'll need to cover any unused bar codes on this and the facing page to ensure that the scanner reads only the bar code you intend to scan.
3. Complete the programming sequence by scanning the ENTER/EXIT Programming Mode bar code.



★ EAN-13 Minimum Read = 1



EAN-13 Minimum Read = 2



EAN-13 Minimum Read = 3



EAN-13 Minimum Read = 4



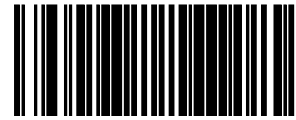

## EAN-8

### EAN-8 Enable

Enables/disables the ability of the scanner to decode EAN/JAN-8 labels.

To set this feature:

1. Scan the Enter/Exit Programming Mode bar code.
2. Scan either the enable or disable bar code below. You'll need to cover any unused bar codes on this and the facing page to ensure that the scanner reads only the bar code you intend to scan.
3. Complete the programming sequence by scanning the Enter/Exit Programming Mode bar code.



EAN-8 = Disable



★ EAN-8 = Enable

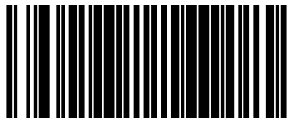

## EAN-8 Check Character Transmission

Enables/disables transmission of an EAN/JAN-8 check character.



**NOTE: This item is ignored when the advanced feature, Full Label Edit, is enabled.**

To set this feature:

1. Scan the Enter/Exit Programming Mode bar code.
2. Scan either the enable or disable bar code below. You'll need to cover any unused bar codes on this and the facing page to ensure that the scanner reads only the bar code you intend to scan.
3. Complete the programming sequence by scanning the Enter/Exit Programming Mode bar code.



EAN-8 Check Character Transmission = Disable



★ EAN-8 Check Character Transmission = Enable

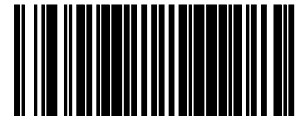

## Expand EAN-8 to EAN-13

Enables/disables expansion of EAN/JAN-8 labels to EAN/JAN-13.

To set this feature:

1. Scan the Enter/Exit Programming Mode bar code.
2. Scan either the enable or disable bar code below. You'll need to cover any unused bar codes on this and the facing page to ensure that the scanner reads only the bar code you intend to scan.
3. Complete the programming sequence by scanning the Enter/Exit Programming Mode bar code.



★ Expand EAN-8 to EAN-13 = Disable



Expand EAN-8 to EAN-13 = Enable

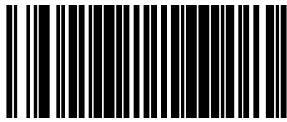

## EAN-8 Minimum Read

This feature specifies the minimum number of consecutive EAN-8 decodes before is accepted as good read.

To set this feature:

1. Scan the ENTER/EXIT Programming Mode bar code.
2. Scan your selection from the bar codes below. You'll need to cover any unused bar codes on this and the facing page to ensure that the scanner reads only the bar code you intend to scan.
3. Complete the programming sequence by scanning the ENTER/EXIT Programming Mode bar code.



★ EAN-8 Minimum Read = 1



EAN-8 Minimum Read = 2



EAN-8 Minimum Read = 3



EAN-8 Minimum Read = 4

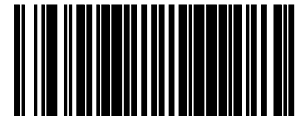

## EAN-8 Guard Insertion

This setting enables the insertion of either a missing leading or trailing guard to a scanned bar code.

To set this feature:

1. Scan the Enter/Exit Programming Mode bar code.
2. Scan either the enable or disable bar code below. You'll need to cover any unused bar codes on this and the facing page to ensure that the scanner reads only the bar code you intend to scan.
3. Complete the programming sequence by scanning the Enter/Exit Programming Mode bar code.



★ EAN-8 Guard Insertion = Disable



EAN-8 Guard Insertion = Enable

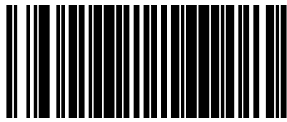

## EAN-8 Guard Substitution

This setting enables the scanner to substitute a guard pattern for even-parity 6 for EAN8/JAN8 labels.

To set this feature:

1. Scan the Enter/Exit Programming Mode bar code.
2. Scan either the enable or disable bar code below. You'll need to cover any unused bar codes on this and the facing page to ensure that the scanner reads only the bar code you intend to scan.
3. Complete the programming sequence by scanning the Enter/Exit Programming Mode bar code.



★ EAN-8 Guard Insertion = Disable



EAN-8 Guard Insertion = Enable

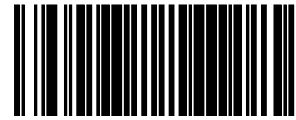

## EAN-8/Jan-8 Both Guards Substitution

Enables/disables the ability of the scanner to find an EAN/JAN8 guard pattern in cases where the EAN/JAN8 margin makes the guard look like a character.

To set this feature:

1. Scan the Enter/Exit Programming Mode bar code.
2. Scan either the enable or disable bar code below. You'll need to cover any unused bar codes on this and the facing page to ensure that the scanner reads only the bar code you intend to scan.
3. Complete the programming sequence by scanning the Enter/Exit Programming Mode bar code.



★ EAN-8/JAN-8 Both Guards Substitution = Disable



EAN-8/JAN-8 Both Guards Substitution = Enable

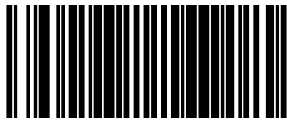

## EAN-8 Stitch Exact Label Halves

This setting enables the stitching of exact EAN-8 label halves with no overlapping characters.

To set this feature:

1. Scan the Enter/Exit Programming Mode bar code.
2. Scan either the enable or disable bar code below. You'll need to cover any unused bar codes on this and the facing page to ensure that the scanner reads only the bar code you intend to scan.
3. Complete the programming sequence by scanning the Enter/Exit Programming Mode bar code.



★ EAN-8 Stitch Exact Label Halves = Disable



EAN-8 Stitch Exact Label Halves = Enable



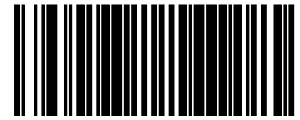

## EAN-8 Stitch Unlike Label Halves

This setting enables the stitching of two EAN-8 label halves together that may have different characters.

To set this feature:

1. Scan the Enter/Exit Programming Mode bar code.
2. Scan either the enable or disable bar code below. You'll need to cover any unused bar codes on this and the facing page to ensure that the scanner reads only the bar code you intend to scan.
3. Complete the programming sequence by scanning the Enter/Exit Programming Mode bar code.



★ EAN-8 Stitch Unlike Label Halves = Disable



EAN-8 Stitch Unlike Label Halves = Enable

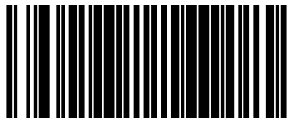

## EAN-8 Minimum Segment Length

Specifies the minimum number of characters necessary in an EAN-8/JAN-8 label segment in order for the scanner to accept a label for decoding. Selectable from 5 to 15 characters. Default setting for this feature is: 08 (8 characters).



EAN-8 Minimum Segment Length = 5 characters



EAN-8 Minimum Segment Length = 6 characters



EAN-8 Minimum Segment Length = 7 characters



★ EAN-8 Minimum Segment Length = 8 characters



EAN-8 Minimum Segment Length = 9 characters



EAN-8 Minimum Segment Length = 10 characters



EAN-8 Minimum Segment Length = 11 characters

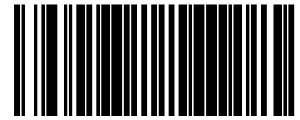

### EAN-8 Minimum Segment Length (continued)



EAN-8 Minimum Segment Length = 12 characters



EAN-8 Minimum Segment Length = 13 characters



EAN-8 Minimum Segment Length = 14 characters



EAN-8 Minimum Segment Length = 15 characters

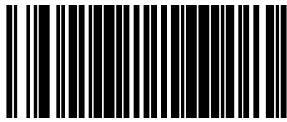

## EAN-8 Decoding Levels

Decoding levels allow the decoder to be set to perform at one of four selectable levels:

- Very Conservative — Slower scan time, virtually eliminates misreads. The most secure setting.
- Slightly More Aggressive — Faster scanning, more aggressive, yet minimizes misreads.
- Moderately Aggressive — Even faster scanning, even more aggressive.
- Very Aggressive — Fastest scan speed, most aggressive.



**CAUTION: Use caution when setting this feature, as more aggressive settings for this feature allow a higher potential for misreads.**



★ EAN-8 Decoding Level = Very Conservative



EAN-8 Decoding Level = Slightly More Aggressive



EAN-8 Decoding Level = Moderately Aggressive



EAN-8 Decoding Level = Very Aggressive

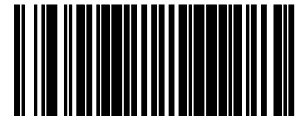

## OTHER UPC/EAN OPTIONS

The following pages contain other selectable features for UPC/EAN symbologies:

In-Store Printed Label Minimum Read	UPC/EAN Minimum Segment Length
UPC/EAN Correlation	Price Weight Check
UPC/EAN Guard Insertion	Enable EAN Two Label
UPC/EAN Stitch Exact Label Halves	Add-ons
UPC/EAN Stitch Unlike Label Halves	

### In-Store Printed Label Minimum Read

This feature specifies the minimum number of consecutive In-Store Printed Label decodes before is accepted as good read.

To set this feature:

1. Scan the ENTER/EXIT Programming Mode bar code.
2. Scan your selection from the bar codes below. You'll need to cover any unused bar codes on this and the facing page to ensure that the scanner reads only the bar code you intend to scan.
3. Complete the programming sequence by scanning the ENTER/EXIT Programming Mode bar code.



★ In-Store Printed Label Minimum Read = 1



In-Store Printed Label Minimum Read = 2



In-Store Printed Label Minimum Read = 3



In-Store Printed Label Minimum Read = 4

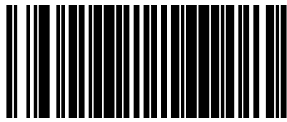

## UPC/EAN Correlation

Enables/disables character correlation for UPC/EAN.

To set this feature:

1. Scan the ENTER/EXIT Programming Mode bar code.
2. Scan either the enable or disable bar code below. You'll need to cover any unused bar codes on this and the facing page to ensure that the scanner reads only the bar code you intend to scan.
3. Complete the programming sequence by scanning the ENTER/EXIT Programming Mode bar code.



★ UPC/EAN Correlation = Disable



UPC/EAN Correlation = Enable

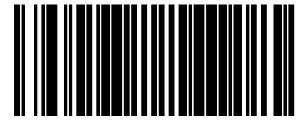

## UPC/EAN Guard Insertion

This setting enables the insertion of either a missing leading or trailing guard to a scanned bar code.

To set this feature:

1. Scan the Enter/Exit Programming Mode bar code.
2. Scan either the enable or disable bar code below. You'll need to cover any unused bar codes on this and the facing page to ensure that the scanner reads only the bar code you intend to scan.
3. Complete the programming sequence by scanning the Enter/Exit Programming Mode bar code.



★ UPC/EAN Guard Insertion = Disable



UPC/EAN Guard Insertion = Enable

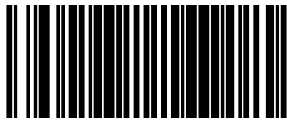

## UPC/EAN Stitch Exact Label Halves

This setting enables the stitching of exact UPC-A/EAN-13 label halves with no overlapping characters.

To set this feature:

1. Scan the Enter/Exit Programming Mode bar code.
2. Scan either the enable or disable bar code below. You'll need to cover any unused bar codes on this and the facing page to ensure that the scanner reads only the bar code you intend to scan.
3. Complete the programming sequence by scanning the Enter/Exit Programming Mode bar code.



★UPC/EAN Stitch Exact Label Halves = Disable



UPC/EAN Stitch Exact Label Halves = Enable



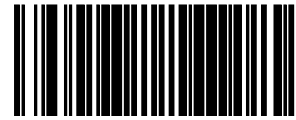

## UPC/EAN Stitch Unlike Label Halves

This setting enables the stitching of two UPC-A/EAN-13 label halves together that may have different characters.

To set this feature:

1. Scan the Enter/Exit Programming Mode bar code.
2. Scan either the enable or disable bar code below. You'll need to cover any unused bar codes on this and the facing page to ensure that the scanner reads only the bar code you intend to scan.
3. Complete the programming sequence by scanning the Enter/Exit Programming Mode bar code.



★ UPC/EAN Stitch Unlike Label Halves = Disable



UPC/EAN Stitch Unlike Label Halves = Enable

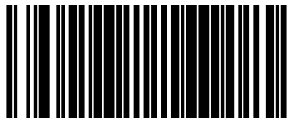

## UPC/EAN Minimum Segment Length

This feature specifies the minimum number of characters needed in a UPC/EAN segment in order to be accepted for decoding.

To set this feature:

1. Scan the Enter/Exit Programming Mode bar code.
2. Scan the bar code for the desired setting below. You'll need to cover any unused bar codes on this and the facing page to ensure that the scanner reads only the bar code you intend to scan.
3. Complete the programming sequence by scanning the Enter/Exit Programming Mode bar code.



★UPC/EAN Minimum Segment Length = 5 Characters



UPC/EAN Minimum Segment Length = 6 Characters



UPC/EAN Minimum Segment Length = 7 Characters



UPC/EAN Minimum Segment Length = 8 Characters



UPC/EAN Minimum Segment Length = 9 Characters



UPC/EAN Minimum Segment Length = 10 Characters

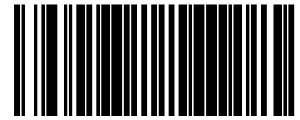

## UPC/EAN Minimum Segment Length — continued



UPC/EAN Minimum Segment Length = 11 Characters



UPC/EAN Minimum Segment Length = 12 Characters



UPC/EAN Minimum Segment Length = 13 Characters



UPC/EAN Minimum Segment Length = 14 Characters



UPC/EAN Minimum Segment Length = 15 Characters

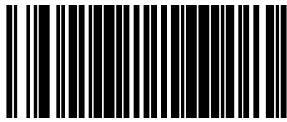

## Price Weight Check

Enables/disables calculation and verification of price/weight check digits. Applies to all UPC-A and EAN/JAN-13 labels with eligible<sup>1</sup> Number System/First Character digits.

Options are:

- Disable
- 4-digit price/weight
- 5-digit price/weight
- 4-digit European price/weight
- 5-digit European price/weight

To set this feature:

1. Scan the Enter/Exit Programming Mode bar code.
2. Scan the bar code representing the desired option below or on the following pages. You'll need to cover any unused bar codes on facing pages to ensure that the scanner reads only the bar code you intend to scan.
3. Complete the programming sequence by scanning the Enter/Exit Programming Mode bar code.



★ Price Weight Check = Disable



Price Weight Check = 4-digit price/weight



Price Weight Check = 5-digit price/weight



Price Weight Check = 4-digit European price/weight

---

1. Price Weight Check generally applies to UPC-A labels with a Number System Digit of 2 and EAN/JAN-13 labels with a First Character of 2. There are a total of six flag digits corresponding to the six types. Checking applies depending upon which type is enabled.

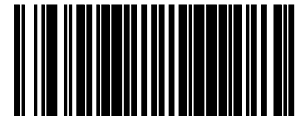

## Price Weight Check — continued



Price Weight Check = 5-digit European price/weight

## Enable EAN Two Label

Enables/disables the ability of the scanner to decode EAN two-label pairs.

To set this feature:

1. Scan the Enter/Exit Programming Mode bar code.
2. Scan either the enable or disable bar code below. You'll need to cover any unused bar codes on this and the facing page to ensure that the scanner reads only the bar code you intend to scan.
3. Complete the programming sequence by scanning the Enter/Exit Programming Mode bar code.



**NOTE: Contact Customer Support for details about advanced programming for this feature.**



★ EAN Two Label = Disable



EAN Two Label = Enable

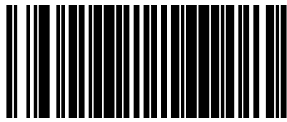

## EAN Two Label Minimum Read

This feature specifies the minimum number of consecutive EAN Two Label decodes before is accepted as good read.

To set this feature:

1. Scan the ENTER/EXIT Programming Mode bar code.
2. Scan your selection from the bar codes below. You'll need to cover any unused bar codes on this and the facing page to ensure that the scanner reads only the bar code you intend to scan.
3. Complete the programming sequence by scanning the ENTER/EXIT Programming Mode bar code.



★ EAN Two Label Minimum Read = 1



EAN Two Label Minimum Read = 2



EAN Two Label Minimum Read = 3



EAN Two Label Minimum Read = 4

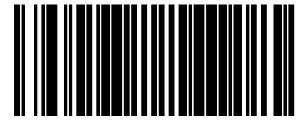

## EAN Two Label Combined Transmission

Enables/disables the transmitting of an EAN two label pair as one label.

To set this feature:

1. Scan the Enter/Exit Programming Mode bar code.
2. Scan either the enable or disable bar code below. You'll need to cover any unused bar codes on this and the facing page to ensure that the scanner reads only the bar code you intend to scan.
3. Complete the programming sequence by scanning the Enter/Exit Programming Mode bar code.



★ EAN Two Label Combined Transmission = Disable



EAN Two Label Combined Transmission = Enable

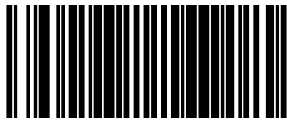

## Add-ons

The scanner is capable of processing different types of add-on codes, including:

- 2-Digit Supplemental
- 5-Digit Supplemental

Options are provided on the following pages for your convenience:

- Disable all add-ons — The scanner will not look for or read add-ons.
- Optional 2-Digit and 5-Digit Supplemental — Bar Codes can be read which include 2-Digit or 5-Digit Supplementals, however, it is not required that add-ons be included in bar codes.



**NOTE: Contact customer support for advanced programming of optional and conditional add-ons.**

To set this feature:

1. Scan the Enter/Exit Programming Mode bar code.
2. Scan the bar code representing the desired option on this and the following page. You'll need to cover any unused bar codes on facing pages to ensure that the scanner reads only the bar code you intend to scan.
3. Complete the programming sequence by scanning the Enter/Exit Programming Mode bar code.



★ Add-ons = Disable All Add-ons



Add-ons = Optional 2-Digit and 5-Digit Supplemental



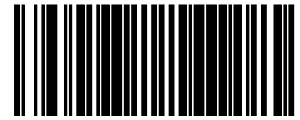

## P2 Add-on Minimum Read

This feature specifies the minimum number of times a P2 add-on must decode before it is marked valid.

To set this feature:

1. Scan the Enter/Exit Programming Mode bar code.
2. Scan the bar code representing the desired option on this and the following page. You'll need to cover any unused bar codes on facing pages to ensure that the scanner reads only the bar code you intend to scan.
3. Complete the programming sequence by scanning the Enter/Exit Programming Mode bar code.



★ P2 Add-on Minimum Read = 2



P2 Add-on Minimum Read = 3



P2 Add-on Minimum Read = 4



P2 Add-on Minimum Read = 5



P2 Add-on Minimum Read = 6



P2 Add-on Minimum Read = 7

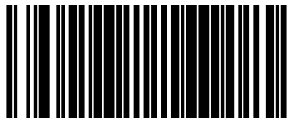

## P2 Add-on Minimum Read — continued



P2 Add-on Minimum Read = 8



P2 Add-on Minimum Read = 9



P2 Add-on Minimum Read = 10



P2 Add-on Minimum Read = 11



P2 Add-on Minimum Read = 12



P2 Add-on Minimum Read = 13



P2 Add-on Minimum Read = 14



P2 Add-on Minimum Read = 15

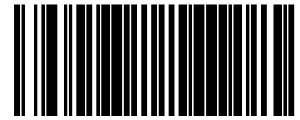

## P5 Add-on Minimum Read

This feature specifies the minimum number of times a P5 add-on must decode before it is marked valid.

To set this feature:

1. Scan the Enter/Exit Programming Mode bar code.
2. Scan the bar code representing the desired option on this and the following page. You'll need to cover any unused bar codes on facing pages to ensure that the scanner reads only the bar code you intend to scan.
3. Complete the programming sequence by scanning the Enter/Exit Programming Mode bar code.



★ P5 Add-on Minimum Read = 1



P5 Add-on Minimum Read = 2



P5 Add-on Minimum Read = 3



P5 Add-on Minimum Read = 4



P5 Add-on Minimum Read = 5



P5 Add-on Minimum Read = 6

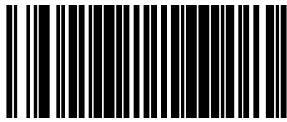

## P5 Add-on Minimum Read — continued



P5 Add-on Minimum Read = 7



P5 Add-on Minimum Read = 8



P5 Add-on Minimum Read = 9



P5 Add-on Minimum Read = 10



P5 Add-on Minimum Read = 11



P5 Add-on Minimum Read = 12



P5 Add-on Minimum Read = 13



P5 Add-on Minimum Read = 14

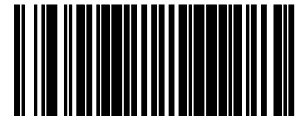

## P5 Add-on Minimum Read — continued



P5 Add-on Minimum Read = 15

## UPC/EAN Composites

Enables/Disables Composites for the UPC/EAN families of labels.

Options are:

To set this feature:

1. Scan the Enter/Exit Programming Mode bar code.
2. Scan the bar code below. You'll need to cover any unused bar codes on this and the facing page to ensure that the scanner reads only the bar code you intend to scan.
3. Scan the appropriate digits from the [Alpha-Numeric Keypad](#) that represent the desired number. The selectable range is 0-15 resets. Pad all single and double digit numbers with leading zeroes to yield a two-digit entry (00-15).
4. Complete the programming sequence by scanning the Enter/Exit Programming Mode bar code.

Default setting for this feature is:

★00 - Disabled



SetUPC/EAN Composites

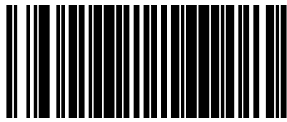

## GTIN

### GTIN Enable

Enables/Disables the ability to convert UPCE, UPCA, EAN8, and EAN13 labels into the GTIN 14-character format.



**NOTE: If add-on information is present on the base label prior to the conversion taking place, the add-on information will be appended to the converted GTIN bar code.**

To set this feature:

1. Scan the Enter/Exit Programming Mode bar code.
2. Scan either the enable or disable bar code below. You'll need to cover any unused bar codes on this and the facing page to ensure that the scanner reads only the bar code you intend to scan.
3. Complete the programming sequence by scanning the Enter/Exit Programming Mode bar code.



★GTIN = Disable



GTIN = Enable

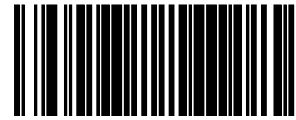

## GS1 DATABAR

The symbology family GS1 DataBar™ was formerly known as Reduced Space Symbology (RSS). For the purpose of simplicity, GS1 DataBar variants are listed in this manual as “DataBar.”

## DATABAR OMNIDIRECTIONAL

### DataBar Omnidirectional Enable

Enables/disables the ability of the scanner to decode DataBar Omnidirectional labels.



**NOTE: This value-added feature is a factory-programmed option. Contact your dealer for information about upgrading your system to include this advanced capability.**

To set this feature:

1. Scan the ENTER/EXIT Programming Mode bar code.
2. Scan either the enable or disable bar code below. You’ll need to cover any unused bar codes on this and the facing page to ensure that the scanner reads only the bar code you intend to scan.
3. Complete the programming sequence by scanning the ENTER/EXIT Programming Mode bar code.



★ DataBar Omnidirectional = Disable



DataBar Omnidirectional = Enable

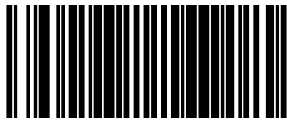

## DataBar Omnidirectional/EAN-128 Emulation

Enables/disables the ability of DataBar Omnidirectional to be transmitted as EAN-128.

1. To set this feature:
2. Scan the ENTER/EXIT Programming Mode bar code.
3. Scan either the enable or disable bar code below. You'll need to cover any unused bar codes on this and the facing page to ensure that the scanner reads only the bar code you intend to scan.
4. Complete the programming sequence by scanning the ENTER/EXIT Programming Mode bar code.



★ DataBar Omnidirectional/EAN-128 Emulation =  
Disable



DataBar Omnidirectional/EAN-128 Emulation = Enable



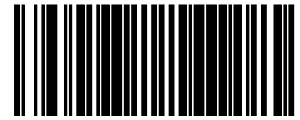

ENTER/EXIT PROGRAMMING MODE

## DataBar Omnidirectional 2D Component Enable

When this feature is enabled, the software will not decode an DataBar Omnidirectional bar code with a 2D component associated with it, and the 2D component will be discarded.

To set this feature:

1. Scan the ENTER/EXIT Programming Mode bar code.
2. Scan your selection from the bar codes below. You'll need to cover any unused bar codes on this and the facing page to ensure that the scanner reads only the bar code you intend to scan.
3. Complete the programming sequence by scanning the ENTER/EXIT Programming Mode bar code.



★ DataBar Omnidirectional 2D Component = Disable



DataBar Omnidirectional 2D Component = Enable

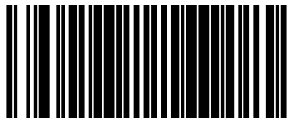

## DataBar Omnidirectional Minimum Read

This feature specifies the minimum number of consecutive DataBar Omnidirectional decodes before is accepted as good read.

To set this feature:

1. Scan the ENTER/EXIT Programming Mode bar code.
2. Scan your selection from the bar codes below. You'll need to cover any unused bar codes on this and the facing page to ensure that the scanner reads only the bar code you intend to scan.
3. Complete the programming sequence by scanning the ENTER/EXIT Programming Mode bar code.



★ DataBar Omnidirectional Minimum Read = 1



DataBar Omnidirectional Minimum Read = 2



DataBar Omnidirectional Minimum Read = 3



DataBar Omnidirectional Minimum Read = 4

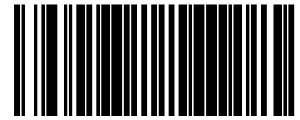

## DataBar Omnidirectional Double Read Timeout

Specifies the minimum allowable time which must pass before reading the same DataBar Omnidirectional label again (e.g. two identical items in succession).

To set this feature:

1. Scan the Enter/Exit Programming Mode bar code.
2. Scan your selection from the bar codes below. You'll need to cover any unused bar codes on this and the facing page to ensure that the scanner reads only the bar code you intend to scan.
3. Complete the programming sequence by scanning the Enter/Exit Programming Mode bar code.



DataBar Omnidirectional Double Read  
Timeout = 0.5 Seconds



DataBar Omnidirectional Double Read  
Timeout = 1 Second



★ DataBar Omnidirectional Double Read  
Timeout = 2.5 Seconds



DataBar Omnidirectional Double Read  
Timeout = 3 Seconds



DataBar Omnidirectional Double Read  
Timeout = 3.5 Seconds

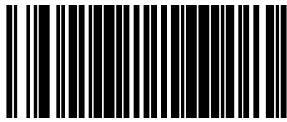

ENTER/EXIT PROGRAMMING MODE

---

## DATABAR LIMITED

### DataBar Limited Enable

Enables/disables the ability of the scanner to decode DataBar Limited labels.

To set this feature:

1. Scan the ENTER/EXIT Programming Mode bar code.
2. Scan either the enable or disable bar code below. You'll need to cover any unused bar codes on this and the facing page to ensure that the scanner reads only the bar code you intend to scan.
3. Complete the programming sequence by scanning the ENTER/EXIT Programming Mode bar code.



★ Databar Limited = Disable



Databar Limited = Enable

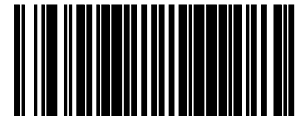

## DataBar Limited Minimum Read

This feature specifies the minimum number of consecutive Databar Limited decodes before is accepted as good read.

To set this feature:

1. Scan the ENTER/EXIT Programming Mode bar code.
2. Scan either the enable or disable bar code below. You'll need to cover any unused bar codes on this and the facing page to ensure that the scanner reads only the bar code you intend to scan.
3. Complete the programming sequence by scanning the ENTER/EXIT Programming Mode bar code.



★ Databar Limited Minimum Read = 1



Databar Limited Minimum Read = 2



Databar Limited Minimum Read = 3



Databar Limited Minimum Read = 4

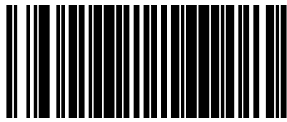

## DataBar Limited 2D Component Enable

This feature controls if a 2D label component be decoded when a Databar Limited base label is decoded.

To set this feature:

1. Scan the ENTER/EXIT Programming Mode bar code.
2. Scan either the enable or disable bar code below. You'll need to cover any unused bar codes on this and the facing page to ensure that the scanner reads only the bar code you intend to scan.
3. Complete the programming sequence by scanning the ENTER/EXIT Programming Mode bar code.



★ Databar Limited 2D Component = Disable



Databar Limited 2D Component = Enable

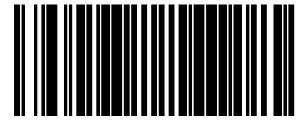

## DataBar Limited EAN128 Emulation Enable

Enables/disables GS1-EAN128 emulation for GS1 Databar Limited.

To set this feature:

1. Scan the ENTER/EXIT Programming Mode bar code.
2. Scan either the enable or disable bar code below. You'll need to cover any unused bar codes on this and the facing page to ensure that the scanner reads only the bar code you intend to scan.
3. Complete the programming sequence by scanning the ENTER/EXIT Programming Mode bar code.



★ Databar Limited EAN128 Emulation = disable



Databar Limited EAN128 Emulation = enable

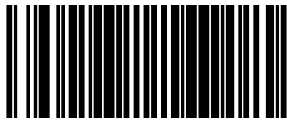

## DATABAR EXPANDED

### DataBar Expanded Enable

Enables/disables the ability of the scanner to decode DataBar Expanded labels.



**NOTE: This value-added feature is a factory-programmed option. Contact your dealer for information about upgrading your system to include this advanced capability.**

To set this feature:

1. Scan the ENTER/EXIT Programming Mode bar code.
2. Scan either the enable or disable bar code below. You'll need to cover any unused bar codes on this and the facing page to ensure that the scanner reads only the bar code you intend to scan.
3. Complete the programming sequence by scanning the ENTER/EXIT Programming Mode bar code.



★ DataBar Expanded = Disable



DataBar Expanded = Enable



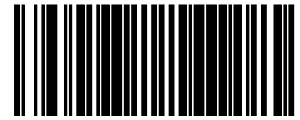

## DataBar Expanded EAN-128 Emulation

Enables/disables EAN 128 emulation for DataBar Expanded.

To set this feature:

1. Scan the ENTER/EXIT Programming Mode bar code.
2. Scan either the enable or disable bar code below. You'll need to cover any unused bar codes on this and the facing page to ensure that the scanner reads only the bar code you intend to scan.
3. Complete the programming sequence by scanning the ENTER/EXIT Programming Mode bar code.



★ DataBar Expanded EAN-128 Emulation = Disable



DataBar Expanded EAN-128 Emulation = Enable

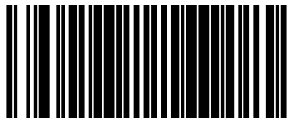

ENTER/EXIT PROGRAMMING MODE

---

## DataBar Expanded 2D Component Enable

When this feature is enabled, the software will not decode an DataBar Expanded bar code with a 2D component associated with it, and the 2D component will be discarded.

To set this feature:

1. Scan the ENTER/EXIT Programming Mode bar code.
2. Scan your selection from the bar codes below. You'll need to cover any unused bar codes on this and the facing page to ensure that the scanner reads only the bar code you intend to scan.
3. Complete the programming sequence by scanning the ENTER/EXIT Programming Mode bar code.



★ DataBar Expanded 2D Component = Disable



DataBar Expanded 2D Component = Enable

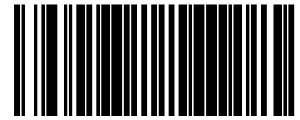

## DataBar Expanded Minimum Read

This feature specifies the minimum number of consecutive DataBar Expanded decodes before is accepted as good read.

To set this feature:

1. Scan the ENTER/EXIT Programming Mode bar code.
2. Scan your selection from the bar codes below. You'll need to cover any unused bar codes on this and the facing page to ensure that the scanner reads only the bar code you intend to scan.
3. Complete the programming sequence by scanning the ENTER/EXIT Programming Mode bar code.



★ DataBar Expanded Minimum Read = 1



DataBar Expanded Minimum Read = 2



DataBar Expanded Minimum Read = 3



DataBar Expanded Minimum Read = 4

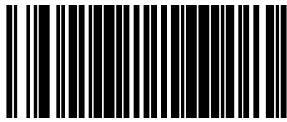

## DataBar Expanded Length Control

This feature specifies either variable-length or fixed-length decoding for DataBar Expanded.

To set this feature:

1. Scan the ENTER/EXIT Programming Mode bar code.
2. Scan your selection from the bar codes below. You'll need to cover any unused bar codes on this and the facing page to ensure that the scanner reads only the bar code you intend to scan.
3. Complete the programming sequence by scanning the ENTER/EXIT Programming Mode bar code.



★ DataBar Expanded Length Control = Variable Length



DataBar Expanded Length Control = Fixed Length

## DataBar Expanded Length 1

Length 1 is the minimum label length if in variable length mode, or the first fixed length if in fixed length mode. Length includes the bar code's data characters only.

To set this feature:

1. Scan the ENTER/EXIT Programming Mode bar code.
2. Scan the bar code, [Set DataBar Expanded Length 1](#) below. You'll need to cover any unused bar codes on this and the facing page to ensure that the scanner reads only the bar code you intend to scan.
3. Scan the appropriate digits from the [Alpha-Numeric Keypad in Appendix C](#) that represent the desired label length. The selectable range for this option is 00 to 74. Pad all single digit numbers with a leading zero to yield a two-digit entry (00-74).
4. Complete the programming sequence by scanning the ENTER/EXIT Programming Mode bar code.

★ Default setting for this feature = 01



Set DataBar Expanded Length 1

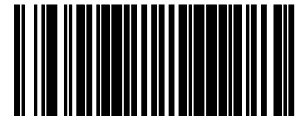

## DataBar Expanded Length 2

Length 2 is the maximum label length if in variable length mode, or the second fixed length if in fixed length mode. Length includes the bar code's data characters only.



**NOTE: When in Fixed Length mode, if Length 2 is set to the value of 00 (zero), then only Length 1 will apply.**

To set this feature:

1. Scan the ENTER/EXIT Programming Mode bar code.
2. Scan the bar code, [Set DataBar Expanded Length 2](#) below. You'll need to cover any unused bar codes on this and the facing page to ensure that the scanner reads only the bar code you intend to scan.
3. Scan the appropriate digits from the [Alpha-Numeric Keypad in Appendix C](#) that represent the desired label length. The selectable range for this option is 00 to 74. Pad all single digit numbers with a leading zero to yield a two-digit entry (00-74).
4. Complete the programming sequence by scanning the ENTER/EXIT Programming Mode bar code.

★ Default setting for this feature = 4A (length = 74)



Set DataBar Expanded Length 2

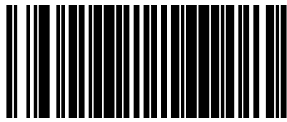

## DataBar Expanded Reverse Retry

Enables/disables the reading of out of specification labels where the last row has been printed in reverse.

- When enabled, DataBar Expanded Stacked labels that have the last row incorrectly printed in reverse will be re-decoded.
- When disabled, DataBar Expanded Stacked labels that have the last row incorrectly printed in reverse will not be read.

To set this feature:

1. Scan the ENTER/EXIT Programming Mode bar code.
2. Scan your selection from the bar codes below. You'll need to cover any unused bar codes on this and the facing page to ensure that the scanner reads only the bar code you intend to scan.
3. Complete the programming sequence by scanning the ENTER/EXIT Programming Mode bar code.



★ DataBar Expanded Reverse Retry = Disable



DataBar Expanded Reverse Retry = Enable

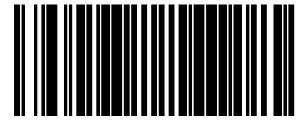

## CODE 39

### Code 39 Enable

Enables/disables the ability of the scanner to decode Code 39 labels.

To set this feature:

1. Scan the ENTER/EXIT Programming Mode bar code.
2. Scan either the enable or disable bar code below. You'll need to cover any unused bar codes on this and the facing page to ensure that the scanner reads only the bar code you intend to scan.
3. Complete the programming sequence by scanning the ENTER/EXIT Programming Mode bar code.



Code 39 = Disable



★ Code 39 = Enable

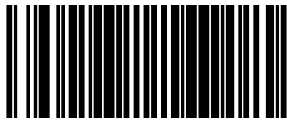

## Code 39 Start Stop Character Transmission

Enables/disables transmission of Code 39 start and stop characters.



**NOTE: This item is ignored when the advanced feature, Full Label Edit, is enabled**

To set this feature:

1. Scan the ENTER/EXIT Programming Mode bar code.
2. Scan either the enable or disable bar code below. You'll need to cover any unused bar codes on this and the facing page to ensure that the scanner reads only the bar code you intend to scan.
3. Complete the programming sequence by scanning the ENTER/EXIT Programming Mode bar code.



★ Code 39 Start Stop Character Transmission = Disable



Code 39 Start Stop Character Transmission = Enable



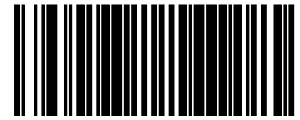

## Code 39 Check Character Calculation

Enables/disables calculation and verification of an optional Code 39 check character. When disabled, any check character in label is treated as a data character.



**NOTE: If check calculation is disabled, the risk is increased that a misread can occur.**

To set this feature:

1. Scan the ENTER/EXIT Programming Mode bar code.
2. Scan either the enable or disable bar code below. You'll need to cover any unused bar codes on this and the facing page to ensure that the scanner reads only the bar code you intend to scan.
3. Complete the programming sequence by scanning the ENTER/EXIT Programming Mode bar code.



★ Code 39 Check Character Calculation = Disable



Code 39 Check Character Calculation = Enable

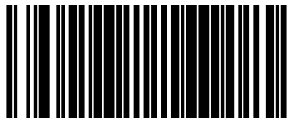

## Code 39 Check Character Transmission

Enables/disables transmission of optional Code 39 check character.



**NOTE: This item is ignored when the advanced feature, Full Label Edit, is enabled.**

To set this feature:

1. Scan the ENTER/EXIT Programming Mode bar code.
2. Scan either the enable or disable bar code below. You'll need to cover any unused bar codes on this and the facing page to ensure that the scanner reads only the bar code you intend to scan.
3. Complete the programming sequence by scanning the ENTER/EXIT Programming Mode bar code.



Code 39 Check Character Transmission = Disable



★ Code 39 Check Character Transmission = Enable

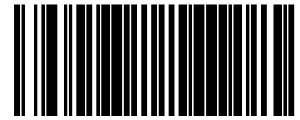

## Code 39 Full ASCII

Enables/disables the ability of the scanner to translate to Code 39 full ASCII labels.

To set this feature:

1. Scan the ENTER/EXIT Programming Mode bar code.
2. Scan either the enable or disable bar code below. You'll need to cover any unused bar codes on this and the facing page to ensure that the scanner reads only the bar code you intend to scan.
3. Complete the programming sequence by scanning the ENTER/EXIT Programming Mode bar code.



★ Code 39 Full ASCII = Disable



Code 39 Full ASCII = Enable

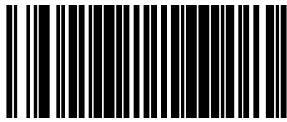

## Code 39 Minimum Read

This feature specifies the minimum number of consecutive Code 39 decodes before is accepted as good read.

To set this feature:

1. Scan the ENTER/EXIT Programming Mode bar code.
2. Scan your selection from the bar codes below. You'll need to cover any unused bar codes on this and the facing page to ensure that the scanner reads only the bar code you intend to scan.
3. Complete the programming sequence by scanning the ENTER/EXIT Programming Mode bar code.



★ Code 39 Minimum Read = 1



Code 39 Minimum Read = 2



Code 39 Minimum Read = 3



Code 39 Minimum Read = 4

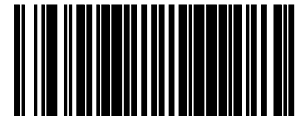

## Code 39 Correlation

Enables/disables character correlation for Code 39.

To set this feature:

1. Scan the ENTER/EXIT Programming Mode bar code.
2. Scan either the enable or disable bar code below. You'll need to cover any unused bar codes on this and the facing page to ensure that the scanner reads only the bar code you intend to scan.
3. Complete the programming sequence by scanning the ENTER/EXIT Programming Mode bar code.



★ Code 39 Correlation = Disable



Code 39 Correlation = Enable

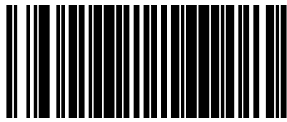

## Code 39 Length Control

This feature specifies whether variable-length or fixed-length decoding will be set for Code 39.

To set this feature:

1. Scan the ENTER/EXIT Programming Mode bar code.
2. Scan your selection from the bar codes below. You'll need to cover any unused bar codes on this and the facing page to ensure that the scanner reads only the bar code you intend to scan.
3. Complete the programming sequence by scanning the ENTER/EXIT Programming Mode bar code.



★ Code 39 Length Control = Variable Length



Code 39 Length Control = Fixed Length

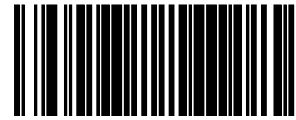

## Code 39 Length 1

If Code 39 Length Control is set to Fixed-Length decoding, this feature specifies Code 39 first fixed length. If Code 39 Length Control is set to Variable-Length decoding, this feature specifies the minimum label length.

To set this feature:

1. Scan the ENTER/EXIT Programming Mode bar code.
2. Scan the bar code, [Set Code 39 Length 1](#) below. You'll need to cover any unused bar codes on this and the facing page to ensure that the scanner reads only the bar code you intend to scan.
3. Scan the appropriate digits from the [Alpha-Numeric Keypad in Appendix C](#) that represent the desired label length. The selectable range for this option is 00 to 50. Pad all single digit numbers with a leading zero to yield a two-digit entry (00-50).
4. Complete the programming sequence by scanning the ENTER/EXIT Programming Mode bar code.

★ Default setting for this feature = 02



Set Code 39 Length 1

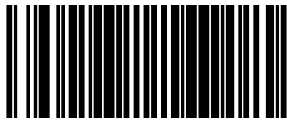

## Code 39 Length 2

If Code 39 Length Control is set to Fixed-Length decoding, this feature specifies Code 39 second fixed length. If Code 39 Length Control is set to Variable-Length decoding, this feature specifies the maximum label length.



**NOTE: When in Fixed Length mode, if Length 2 is set to the value of 00, then only Length 1 will apply**

To set this feature:

1. Scan the ENTER/EXIT Programming Mode bar code.
2. Scan the bar code, [Set Code 39 Length 2](#) below. You'll need to cover any unused bar codes on this and the facing page to ensure that the scanner reads only the bar code you intend to scan.
3. Scan the appropriate digits from the [Alpha-Numeric Keypad in Appendix C](#) that represent the desired label length. The selectable range for this option is 00, no second fixed length, or 01 to 50. Pad all single digit numbers with a leading zero to yield a two-digit entry (00-50).
4. Complete the programming sequence by scanning the ENTER/EXIT Programming Mode bar code.

★ Default setting for this feature = 32 (length = 50)



Set Code 39 Length 2



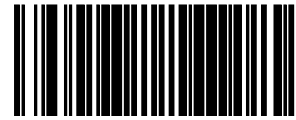

## Code 39 Stitching

Enables/disables stitching for Code 39 labels. When parts of a Code 39 bar code are presented to the scanner with this feature enabled, the bar code parts will be assembled by the scanner's software, and the data will be decoded if all bar code proofing requirements are met.

To set this feature:

1. Scan the ENTER/EXIT Programming Mode bar code.
2. Scan your selection from the bar codes below. You'll need to cover any unused bar codes on this and the facing page to ensure that the scanner reads only the bar code you intend to scan.
3. Complete the programming sequence by scanning the ENTER/EXIT Programming Mode bar code.



Code 39 Stitching = Disable



★ Code 39 Stitching = Enable

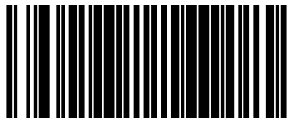

## Code 39 Require Margins

Enables/disables the requirement that quiet zones be present in a Code 39 bar code.

To set this feature:

1. Scan the ENTER/EXIT Programming Mode bar code.
2. Scan either the enable or disable bar code below. You'll need to cover any unused bar codes on this and the facing page to ensure that the scanner reads only the bar code you intend to scan.
3. Complete the programming sequence by scanning the ENTER/EXIT Programming Mode bar code.



★ Code 39 Require Margins = Quiet Zones Not Required



Code 39 Require Margins = Quiet Zones Required

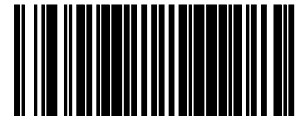

## CODE 32 ITALIAN PHARMACODE

### Code 32 Italian Pharmacode Enable

Enables/disables the ability of the scanner to decode Italian Pharmaceutical Code 39 labels.

To set this feature:

1. Scan the ENTER/EXIT Programming Mode bar code.
2. Scan either the enable or disable bar code below. You'll need to cover any unused bar codes on this and the facing page to ensure that the scanner reads only the bar code you intend to scan.
3. Complete the programming sequence by scanning the ENTER/EXIT Programming Mode bar code.



★ Code 32 Italian Pharmacode Enable = Disable



Code 32 Italian Pharmacode Enable = Enable

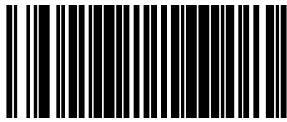

## Code 32 Start Stop Character Transmission

Enables/ disables transmission of start and stop characters for Code 32.



**NOTE: This item is ignored when the advanced feature, Full Label Edit, is enabled.**

To set this feature:

1. Scan the ENTER/EXIT Programming Mode bar code.
2. Scan either the enable or disable bar code below. You'll need to cover any unused bar codes on this and the facing page to ensure that the scanner reads only the bar code you intend to scan.
3. Complete the programming sequence by scanning the ENTER/EXIT Programming Mode bar code.



★ Code 32 Start Stop Character Transmission = Disable



Code 32 Start Stop Character Transmission = Enable

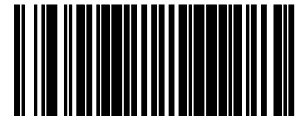

## Code 32 Check Character Transmission

Enables/disables transmission of Code 32 check character.



**NOTE: This item is ignored when the advanced feature, Full Label Edit, is enabled.**

To set this feature:

1. Scan the ENTER/EXIT Programming Mode bar code.
2. Scan either the enable or disable bar code below. You'll need to cover any unused bar codes on this and the facing page to ensure that the scanner reads only the bar code you intend to scan.
3. Complete the programming sequence by scanning the ENTER/EXIT Programming Mode bar code.



★ Code 32 Check Character Transmission = Disable



Code 32 Check Character Transmission = Enable

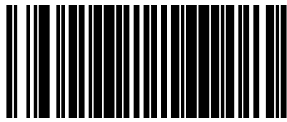

## CODE 128

### Code 128 Enable

Enables/disables the ability of the scanner to decode Code 128 labels.

To set this feature:

1. Scan the ENTER/EXIT Programming Mode bar code.
2. Scan either the enable or disable bar code below. You'll need to cover any unused bar codes on this and the facing page to ensure that the scanner reads only the bar code you intend to scan.
3. Complete the programming sequence by scanning the ENTER/EXIT Programming Mode bar code.



Code 128 = Disable



★ Code 128 = Enable

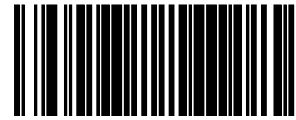

## Code 128 Transmit Function Characters

Enables/disables transmission of Code 128 function characters 1, 2, 3, and 4.



**NOTE: Disabled is the recommended setting for all interfaces.**

To set this feature:

1. Scan the ENTER/EXIT Programming Mode bar code.
2. Scan either the enable or disable bar code below. You'll need to cover any unused bar codes on this and the facing page to ensure that the scanner reads only the bar code you intend to scan.
3. Complete the programming sequence by scanning the ENTER/EXIT Programming Mode bar code.



★ Code 128 Transmit Function Characters = Disable



Code 128 Transmit Function Characters = Enable

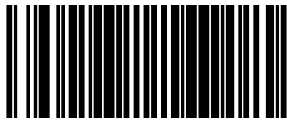

## Expand Code 128 to Code 39

Enables/disables expansion of Code 128 labels to Code 39.

To set this feature:

1. Scan the ENTER/EXIT Programming Mode bar code.
2. Scan either the enable or disable bar code below. You'll need to cover any unused bar codes on this and the facing page to ensure that the scanner reads only the bar code you intend to scan.
3. Complete the programming sequence by scanning the ENTER/EXIT Programming Mode bar code.



★ Expand Code 128 to Code 39 = Disable



Expand Code 128 to Code 39 = Enable



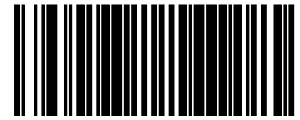

## Code 128 Minimum Read

This feature specifies the minimum number of consecutive Code 128 decodes before is accepted as good read.

To set this feature:

1. Scan the ENTER/EXIT Programming Mode bar code.
2. Scan your selection from the bar codes below. You'll need to cover any unused bar codes on this and the facing page to ensure that the scanner reads only the bar code you intend to scan.
3. Complete the programming sequence by scanning the ENTER/EXIT Programming Mode bar code.



★ Code 128 Minimum Read = 1



Code 128 Minimum Read = 2



Code 128 Minimum Read = 3



Code 128 Minimum Read = 4

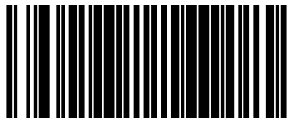

## Code 128 Correlation

Enables/disables character correlation for Code 128.

To set this feature:

1. Scan the ENTER/EXIT Programming Mode bar code.
2. Scan either the enable or disable bar code below. You'll need to cover any unused bar codes on this and the facing page to ensure that the scanner reads only the bar code you intend to scan.
3. Complete the programming sequence by scanning the ENTER/EXIT Programming Mode bar code.



★ Code 128 Correlation = Disable



Code 128 Correlation = Enable

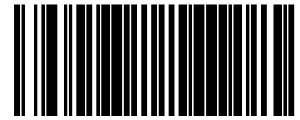

## Code 128 Length Control

This feature specifies whether variable-length or fixed-length decoding will be set for Code 128.

To set this feature:

1. Scan the ENTER/EXIT Programming Mode bar code.
2. Scan your selection from the bar codes below. You'll need to cover any unused bar codes on this and the facing page to ensure that the scanner reads only the bar code you intend to scan.
3. Complete the programming sequence by scanning the ENTER/EXIT Programming Mode bar code.



★ Code 128 Length Control = Variable Length



Code 128 Length Control = Fixed Length

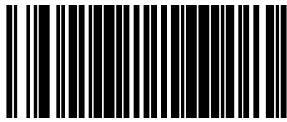

## Code 128 Length 1

If Code 128 Length Control is set to Fixed-Length decoding, this feature specifies Code 128 first fixed length. If Code 128 Length Control is set to Variable-Length decoding, this feature specifies the minimum label length.

To set this feature:

1. Scan the ENTER/EXIT Programming Mode bar code.
2. Scan the bar code, [Set Code 128 Length 1](#) below. You'll need to cover any unused bar codes on this and the facing page to ensure that the scanner reads only the bar code you intend to scan.
3. Scan the appropriate digits from the [Alpha-Numeric Keypad in Appendix C](#) that represent the desired label length. The selectable range for this option is 01 to 80. Pad all single digit numbers with a leading zero to yield a two-digit entry (01-80).
4. Complete the programming sequence by scanning the ENTER/EXIT Programming Mode bar code.

★ Default setting for this feature = 01



Set Code 128 Length 1

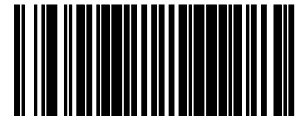

## Code 128 Length 2

If Code 128 Length Control is set to Fixed-Length decoding, this feature specifies Code 128 second fixed length. If Code 128 Length Control is set to Variable-Length decoding, this feature specifies the maximum label length.



**NOTE: When in Fixed Length mode, if Length 2 is set to the value of 00 (zero), then only Length 1 will apply.**

To set this feature:

1. Scan the ENTER/EXIT Programming Mode bar code.
2. Scan the bar code, [Set Code 128 Length 2](#) below. You'll need to cover any unused bar codes on this and the facing page to ensure that the scanner reads only the bar code you intend to scan.
3. Scan the appropriate digits from the [Alpha-Numeric Keypad in Appendix C](#) that represent the desired label length. The selectable range for this option is 01 to 80. Pad all single digit numbers with a leading zero to yield a two-digit entry (01-80).
4. Complete the programming sequence by scanning the ENTER/EXIT Programming Mode bar code.

★ Default setting for this feature = 50 (length = 80)



Set Code 128 Length 2

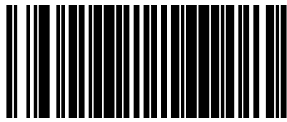

## Code 128 Stitching

Enables/disables stitching for Code 128 labels. When parts of a Code 128 bar code are presented to the scanner with this feature enabled, the bar code parts will be assembled by the scanner's software, and the data will be decoded if all bar code proofing requirements are met.

To set this feature:

1. Scan the ENTER/EXIT Programming Mode bar code.
2. Scan your selection from the bar codes below. You'll need to cover any unused bar codes on this and the facing page to ensure that the scanner reads only the bar code you intend to scan.
3. Complete the programming sequence by scanning the ENTER/EXIT Programming Mode bar code.



Code 128 Stitching = Disable



★ Code 128 Stitching = Enable

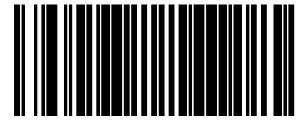

## EAN-128

### EAN-128 Enable

Enables/disables the ability of the scanner to translate EAN128 labels to the EAN128 data format.

To set this feature:

1. Scan the ENTER/EXIT Programming Mode bar code.
2. Scan either the enable or disable bar code below. You'll need to cover any unused bar codes on this and the facing page to ensure that the scanner reads only the bar code you intend to scan.
3. Complete the programming sequence by scanning the ENTER/EXIT Programming Mode bar code.



★ EAN-128 = Transmit EAN128 labels in Code128 data format



EAN-128 = Transmit EAN128 labels in EAN128 data format

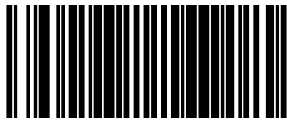

ENTER/EXIT PROGRAMMING MODE

---

## INTERLEAVED 2 OF 5 (I 2 OF 5)

### Interleaved 2 of 5 (I 2 OF 5) Enable

Enables/disables the ability of the scanner to decode Interleaved 2 of 5 labels.

To set this feature:

1. Scan the ENTER/EXIT Programming Mode bar code.
2. Scan either the enable or disable bar code below. You'll need to cover any unused bar codes on this and the facing page to ensure that the scanner reads only the bar code you intend to scan.
3. Complete the programming sequence by scanning the ENTER/EXIT Programming Mode bar code.



★ I 2 of 5 = Disable



I 2 of 5 = Enable



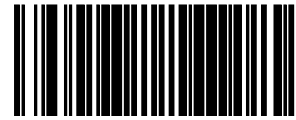

## I 2 of 5 Check Character Calculation

Enables/disables calculation and verification of an optional Interleaved 2 of 5 check character.



**NOTE: If check character calculation is disabled, the risk is increased that a misread can occur. When disabled, any check characters in a bar code are treated as data characters.**

1. To set this feature:
2. Scan the ENTER/EXIT Programming Mode bar code.
3. Scan either the enable or disable bar code below. You'll need to cover any unused bar codes on this and the facing page to ensure that the scanner reads only the bar code you intend to scan.
4. Complete the programming sequence by scanning the ENTER/EXIT Programming Mode bar code.



★ I 2 of 5 Check Character Calculation = Disable



I 2 of 5 Check Character Calculation = Enable

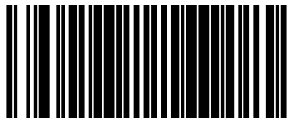

## I 2 of 5 Check Character Transmission

Enables/disables transmission of an optional Interleaved 2 of 5 check character.



**NOTE: This feature applies only when I 2 of 5 Check Character Calculation is enabled. This item is ignored when the advanced feature, Full Label Edit, is enabled.**

To set this feature:

1. Scan the ENTER/EXIT Programming Mode bar code.
2. Scan either the enable or disable bar code below. You'll need to cover any unused bar codes on this and the facing page to ensure that the scanner reads only the bar code you intend to scan.
3. Complete the programming sequence by scanning the ENTER/EXIT Programming Mode bar code.



I 2 of 5 Check Character Transmission = Disable



★ I 2 of 5 Check Character Transmission = Enable

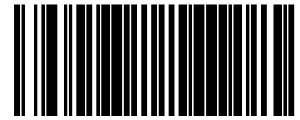

## I 2 of 5 Minimum Read

This feature specifies the minimum number of consecutive I 2 of 5 decodes before is accepted as good read.

To set this feature:

1. Scan the ENTER/EXIT Programming Mode bar code.
2. Scan your selection from the bar codes below. You'll need to cover any unused bar codes on this and the facing page to ensure that the scanner reads only the bar code you intend to scan.
3. Complete the programming sequence by scanning the ENTER/EXIT Programming Mode bar code.



★ I 2 of 5 Minimum Read = 1



I 2 of 5 Minimum Read = 2



I 2 of 5 Minimum Read = 3



I 2 of 5 Minimum Read = 4

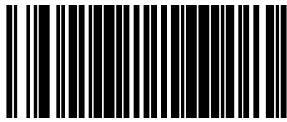

## I 2 of 5 Correlation

Enables/disables character correlation for I 2 of 5.

To set this feature:

1. Scan the ENTER/EXIT Programming Mode bar code.
2. Scan either the enable or disable bar code below. You'll need to cover any unused bar codes on this and the facing page to ensure that the scanner reads only the bar code you intend to scan.
3. Complete the programming sequence by scanning the ENTER/EXIT Programming Mode bar code.



★ I 2 of 5 Correlation = Disable



I 2 of 5 Correlation = Enable

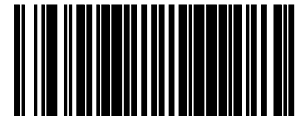

## I 2 of 5 Length Control

This feature specifies whether variable-length or fixed-length decoding will be set for I 2 of 5.

To set this feature:

1. Scan the ENTER/EXIT Programming Mode bar code.
2. Scan your selection from the bar codes below. You'll need to cover any unused bar codes on this and the facing page to ensure that the scanner reads only the bar code you intend to scan.
3. Complete the programming sequence by scanning the ENTER/EXIT Programming Mode bar code.



★ I 2 of 5 Length Control = Variable Length



I 2 of 5 Length Control = Fixed Length

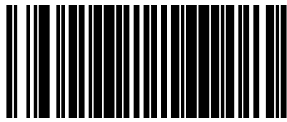

## I 2 of 5 Length 1

If I 2 of 5 Length Control is set to Fixed-Length decoding, this feature specifies I 2 of 5 first fixed length. If I 2 of 5 Length Control is set to Variable-Length decoding, this feature specifies the minimum label length.

To set this feature:

1. Scan the ENTER/EXIT Programming Mode bar code.
2. Scan the bar code, [Set I 2 of 5 Length 1](#) below. You'll need to cover any unused bar codes on this and the facing page to ensure that the scanner reads only the bar code you intend to scan.
3. Scan the appropriate digits from the [Alpha-Numeric Keypad in Appendix C](#) that represent the desired label length. The selectable range for this option is 02 to 50, even numbers only. Pad all single digit numbers with a leading zero to yield a two-digit entry (02-50).
4. Complete the programming sequence by scanning the ENTER/EXIT Programming Mode bar code.

★ Default setting for this feature = Length 06



Set I 2 of 5 Length 1

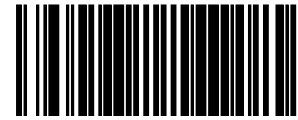

## I 2 of 5 Length 2

If I 2 of 5 Length Control is set to Fixed-Length decoding, this feature specifies I 2 of 5 second fixed length. If I 2 of 5 Length Control is set to Variable-Length decoding, this feature specifies the maximum label length.



**NOTE: When in Fixed Length mode, if Length 2 is set to the value of 00 (zero), then only Length 1 will apply.**

To set this feature:

1. Scan the ENTER/EXIT Programming Mode bar code.
2. Scan the bar code, [Set I 2 of 5 Length 2](#) below. You'll need to cover any unused bar codes on this and the facing page to ensure that the scanner reads only the bar code you intend to scan.
3. Scan the appropriate digits from the [Alpha-Numeric Keypad in Appendix C](#) that represent the desired label length. The selectable range for this option is 00, or 02 to 50; even numbers only. Pad all single digit numbers with a leading zero to yield a two-digit entry (02-50).
4. Complete the programming sequence by scanning the ENTER/EXIT Programming Mode bar code.

★ Default setting for this feature = 32 (length = 50)



Set I 2 of 5 Length 2

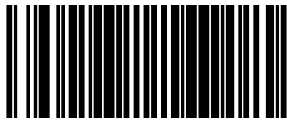

## I 2 of 5 Stitching

Enables/disables stitching for I 2 of 5 labels. When parts of an I 2 of 5 bar code are presented to the scanner with this feature enabled, the bar code parts will be assembled by the scanner's software, and the data will be decoded if all bar code proofing requirements are met.

To set this feature:

1. Scan the ENTER/EXIT Programming Mode bar code.
2. Scan your selection from the bar codes below. You'll need to cover any unused bar codes on this and the facing page to ensure that the scanner reads only the bar code you intend to scan.
3. Complete the programming sequence by scanning the ENTER/EXIT Programming Mode bar code.



★ I 2 of 5 Stitching = Disable



I 2 of 5 Stitching = Enable



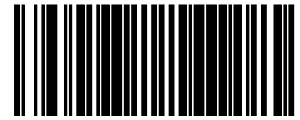

## CODABAR

### Codabar Enable

Enables/disables the ability of the scanner to decode Codabar labels.

To set this feature:

1. Scan the ENTER/EXIT Programming Mode bar code.
2. Scan either the enable or disable bar code below. You'll need to cover any unused bar codes on this and the facing page to ensure that the scanner reads only the bar code you intend to scan.
3. Complete the programming sequence by scanning the ENTER/EXIT Programming Mode bar code.



★ Codabar = Disable



Codabar = Enable

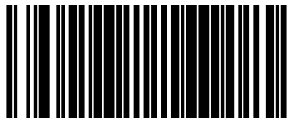

## Codabar Start Stop Character Transmission

Enables/disables transmission of Codabar start and stop characters.



**NOTE: This item is ignored when the advanced feature, Full Label Edit, is enabled.**

To set this feature:

1. Scan the ENTER/EXIT Programming Mode bar code.
2. Scan either the enable or disable bar code below. You'll need to cover any unused bar codes on this and the facing page to ensure that the scanner reads only the bar code you intend to scan.
3. Complete the programming sequence by scanning the ENTER/EXIT Programming Mode bar code.



Codabar Start Stop Character Transmission = Disable



★ Codabar Start Stop Character Transmission = Enable

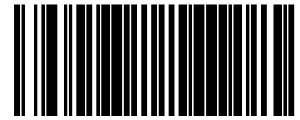

## Codabar Start Stop Character Set

This feature specifies the format of transmitted Codabar start/stop characters.

Options are:

- ABCD/TN\* E
- ABCD/ABCD
- abcd/tn\* e
- abcd/abcd

To set this feature:

1. Scan the ENTER/EXIT Programming Mode bar code.
2. Scan the bar code below or from the following page representing the desired option. You'll need to cover any unused bar codes and facing pages to ensure that the scanner reads only the bar code you intend to scan.
3. Complete the programming sequence by scanning the ENTER/EXIT Programming Mode bar code.



Codabar Start Stop Character Set = ABCD/TN\* E



Codabar Start Stop Character Set = ABCD/ABCD



Codabar Start Stop Character Set = abcd/tn\* e



★ Codabar Start Stop Character Set = abcd/abcd

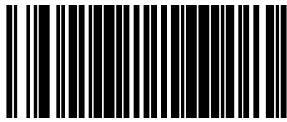

## Codabar Start Stop Character Match

Enables/disables the requirement that Codabar start and stop characters match.

To set this feature:

1. Scan the ENTER/EXIT Programming Mode bar code.
2. Scan either the enable or disable bar code below. You'll need to cover any unused bar codes on this and the facing page to ensure that the scanner reads only the bar code you intend to scan.
3. Complete the programming sequence by scanning the ENTER/EXIT Programming Mode bar code.



★ Codabar Start Stop Character Match = Disable



Codabar Start Stop Character Match = Enable

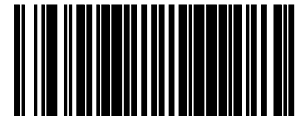

## Codabar Check Character Calculation

Enables/disables calculation and verification of an optional Codabar check character.



**NOTE: If check character calculation is disabled, the risk is increased that a misread can occur. When disabled, any check characters in a bar code are treated as data characters.**

To set this feature:

1. Scan the ENTER/EXIT Programming Mode bar code.
2. Scan either the enable or disable bar code below. You'll need to cover any unused bar codes on this and the facing page to ensure that the scanner reads only the bar code you intend to scan.
3. Complete the programming sequence by scanning the ENTER/EXIT Programming Mode bar code.



★ Codabar Check Character Calculation = Disable



Codabar Check Character Calculation = Enable

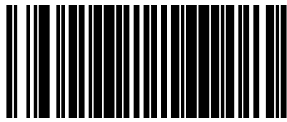

## Codabar Check Character Transmission

Enables/disables transmission of an optional Codabar check character.



**NOTE: Applies only when Codabar Check Character Calculation is enabled. This item is ignored when the advanced feature, Full Label Edit, is enabled.**

To set this feature:

1. Scan the ENTER/EXIT Programming Mode bar code.
2. Scan either the enable or disable bar code below. You'll need to cover any unused bar codes on this and the facing page to ensure that the scanner reads only the bar code you intend to scan.
3. Complete the programming sequence by scanning the ENTER/EXIT Programming Mode bar code.



Codabar Check Character Transmission = Disable



★ Codabar Check Character Transmission = Enable

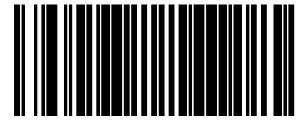

## Codabar Minimum Read

This feature specifies the minimum number of consecutive Codabar decodes before is accepted as good read.

To set this feature:

1. Scan the ENTER/EXIT Programming Mode bar code.
2. Scan your selection from the bar codes below. You'll need to cover any unused bar codes on this and the facing page to ensure that the scanner reads only the bar code you intend to scan.
3. Complete the programming sequence by scanning the ENTER/EXIT Programming Mode bar code.



★ Codabar Minimum Read = 1



Codabar Minimum Read = 2



Codabar Minimum Read = 3



Codabar Minimum Read = 4

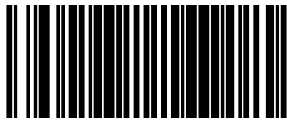

## Codabar Correlation

Enables/disables character correlation for Codabar.

To set this feature:

1. Scan the ENTER/EXIT Programming Mode bar code.
2. Scan either the enable or disable bar code below. You'll need to cover any unused bar codes on this and the facing page to ensure that the scanner reads only the bar code you intend to scan.
3. Complete the programming sequence by scanning the ENTER/EXIT Programming Mode bar code.



★ Codabar Correlation = Disable



Codabar Correlation = Enable



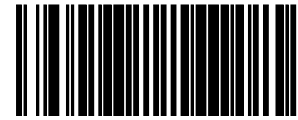

## Codabar Length Control

This feature specifies whether variable-length or fixed-length decoding will be set for Codabar.

To set this feature:

1. Scan the ENTER/EXIT Programming Mode bar code.
2. Scan your selection from the bar codes below. You'll need to cover any unused bar codes on this and the facing page to ensure that the scanner reads only the bar code you intend to scan.
3. Complete the programming sequence by scanning the ENTER/EXIT Programming Mode bar code.



★ Codabar Length Control = Variable Length



Codabar Length Control = Fixed Length

## Codabar Length 1

If Codabar Length Control is set to Fixed-Length decoding, this feature specifies Codabar first fixed length. If Codabar Length Control is set to Variable-Length decoding, this feature specifies the minimum label length.

To set this feature:

1. Scan the ENTER/EXIT Programming Mode bar code.
2. Scan the bar code, [Set Codabar Length 1](#) below. You'll need to cover any unused bar codes on this and the facing page to ensure that the scanner reads only the bar code you intend to scan.
3. Scan the appropriate digits from the [Alpha-Numeric Keypad in Appendix C](#) that represent the desired label length. The selectable range for this option is 03 to 50. Pad all single digit numbers with a leading zero to yield a two-digit entry (03-50).
4. Complete the programming sequence by scanning the ENTER/EXIT Programming Mode bar code.

★ Default setting for this feature = 03



Set Codabar Length 1

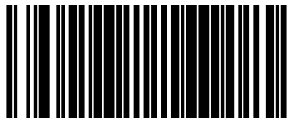

## Codabar Length 2

If Codabar Length Control is set to Fixed-Length decoding, this feature specifies Codabar second fixed length. If Codabar Length Control is set to Variable-Length decoding, this feature specifies the maximum label length.



**NOTE: When in Fixed Length mode, if Length 2 is set to the value of 00 (zero), then only Length 1 will apply.**

To set this feature:

1. Scan the ENTER/EXIT Programming Mode bar code.
2. Scan the bar code, [Set Codabar Length 2](#) below. You'll need to cover any unused bar codes on this and the facing page to ensure that the scanner reads only the bar code you intend to scan.
3. Scan the appropriate digits from the [Alpha-Numeric Keypad in Appendix C](#) that represent the desired label length. The selectable range for this option is 00 (meaning ignore this length), or 03 to 50. Pad all single digit numbers with a leading zero to yield a two-digit entry (03-50).
4. Complete the programming sequence by scanning the ENTER/EXIT Programming Mode bar code.

★ Default setting for this feature is Length = 32 (length = 50)

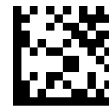

Set Codabar Length 2

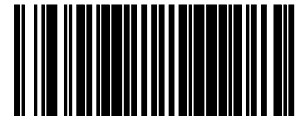

## Codabar Stitching

Enables/disables stitching for Codabar labels. When parts of a Codabar bar code are presented to the scanner with this feature enabled, the bar code parts will be assembled by the scanner's software, and the data will be decoded if all bar code proofing requirements are met.

To set this feature:

1. Scan the ENTER/EXIT Programming Mode bar code.
2. Scan your selection from the bar codes below. You'll need to cover any unused bar codes on this and the facing page to ensure that the scanner reads only the bar code you intend to scan.
3. Complete the programming sequence by scanning the ENTER/EXIT Programming Mode bar code.



★ Codabar Stitching = Disable



Codabar Stitching = Enable

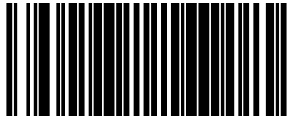

## Codabar Require Margins

Enables/disables the requirement that quiet zones be present in a Codabar bar code.

To set this feature:

1. Scan the ENTER/EXIT Programming Mode bar code.
2. Scan either the enable or disable bar code below. You'll need to cover any unused bar codes on this and the facing page to ensure that the scanner reads only the bar code you intend to scan.
3. Complete the programming sequence by scanning the ENTER/EXIT Programming Mode bar code.



★ Codabar Require Margins = Quiet Zones Not Required



Codabar Require Margins = Quiet Zones Required

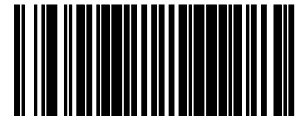

## CODE 93

### Code 93 Enable

Enables/disables the ability of the scanner to decode Code 93 labels.

To set this feature:

1. Scan the ENTER/EXIT Programming Mode bar code.
2. Scan either the enable or disable bar code below. You'll need to cover any unused bar codes on this and the facing page to ensure that the scanner reads only the bar code you intend to scan.
3. Complete the programming sequence by scanning the ENTER/EXIT Programming Mode bar code.



★ Code 93 = Disable



Code 93 = Enable

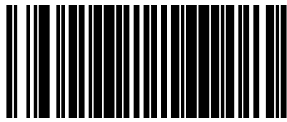

## Code 93 Minimum Read

This feature specifies the minimum number of consecutive Code 93 decodes before is accepted as good read.

To set this feature:

1. Scan the ENTER/EXIT Programming Mode bar code.
2. Scan your selection from the bar codes below. You'll need to cover any unused bar codes on this and the facing page to ensure that the scanner reads only the bar code you intend to scan.
3. Complete the programming sequence by scanning the ENTER/EXIT Programming Mode bar code.



★ Code 93 Minimum Read = 1



Code 93 Minimum Read = 2



Code 93 Minimum Read = 3



Code 93 Minimum Read = 4

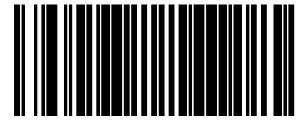

## Code 93 Correlation

Enables/disables character correlation for Code 93.

To set this feature:

1. Scan the ENTER/EXIT Programming Mode bar code.
2. Scan either the enable or disable bar code below. You'll need to cover any unused bar codes on this and the facing page to ensure that the scanner reads only the bar code you intend to scan.
3. Complete the programming sequence by scanning the ENTER/EXIT Programming Mode bar code.



★ Code 93 Correlation = Disable



Code 93 Correlation = Enable

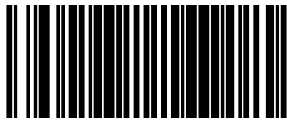

## Code 93 Length Control

This feature specifies whether variable-length or fixed-length decoding will be set for Code 93.

To set this feature:

1. Scan the ENTER/EXIT Programming Mode bar code.
2. Scan your selection from the bar codes below. You'll need to cover any unused bar codes on this and the facing page to ensure that the scanner reads only the bar code you intend to scan.
3. Complete the programming sequence by scanning the ENTER/EXIT Programming Mode bar code.



★ Code 93 Length Control = Variable Length



Code 93 Length Control = Fixed Length

## Code 93 Length 1

If Code 93 Length Control is set to Fixed-Length decoding, this feature specifies Code 93 first fixed length. If Code 93 Length Control is set to Variable-Length decoding, this feature specifies the minimum label length.

To set this feature:

1. Scan the ENTER/EXIT Programming Mode bar code.
2. Scan the bar code, [Set Code 93 Length 1](#) below. You'll need to cover any unused bar codes on this and the facing page to ensure that the scanner reads only the bar code you intend to scan.
3. Scan the appropriate digits from the [Alpha-Numeric Keypad in Appendix C](#) that represent the desired label length. The selectable range for this option is 01 to 50. Pad all single digit numbers with a leading zero to yield a two-digit entry (01-50).
4. Complete the programming sequence by scanning the ENTER/EXIT Programming Mode bar code.

★ Default setting for this feature = 01



Set Code 93 Length 1



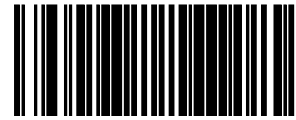

## Code 93 Length 2

If Code 93 Length Control is set to Fixed-Length decoding, this feature specifies Code 93 second fixed length. If Code 93 Length Control is set to Variable-Length decoding, this feature specifies the maximum label length.



**NOTE: When in Fixed Length mode, if Fixed Length 2 is set to the value of 00 (zero), then only Length 1 will apply.**

To set this feature:

1. Scan the ENTER/EXIT Programming Mode bar code.
2. Scan the bar code, [Set Code 93 Length 2](#) below. You'll need to cover any unused bar codes on this and the facing page to ensure that the scanner reads only the bar code you intend to scan.
3. Scan the appropriate digits from the [Alpha-Numeric Keypad in Appendix C](#) that represent the desired label length. The selectable range for this option is 00 (meaning ignore this length), or 01 to 50. Pad all single digit numbers with a leading zero to yield a two-digit entry (01-50).
4. Complete the programming sequence by scanning the ENTER/EXIT Programming Mode bar code.

★ Default setting for this feature = 32 (length = 50)



Set Code 93 Length 2

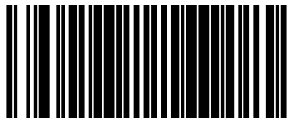

## Code 93 Stitching

Enables/disables stitching for Code 93 labels. When parts of a Code 93 bar code are presented to the scanner with this feature enabled, the bar code parts will be assembled by the scanner's software, and the data will be decoded if all bar code proofing requirements are met.

To set this feature:

1. Scan the ENTER/EXIT Programming Mode bar code.
2. Scan your selection from the bar codes below. You'll need to cover any unused bar codes on this and the facing page to ensure that the scanner reads only the bar code you intend to scan.
3. Complete the programming sequence by scanning the ENTER/EXIT Programming Mode bar code.



Code 93 Stitching = Disable



★ Code 93 Stitching = Enable

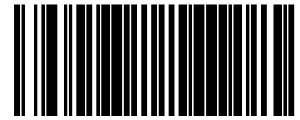

## MSI

### MSI Enable

Enables/disables the ability of the scanner to decode MSI labels.

To set this feature:

1. Scan the ENTER/EXIT Programming Mode bar code.
2. Scan either the enable or disable bar code below. You'll need to cover any unused bar codes on this and the facing page to ensure that the scanner reads only the bar code you intend to scan.
3. Complete the programming sequence by scanning the ENTER/EXIT Programming Mode bar code.



★ MSI = Disable



MSI = Enable

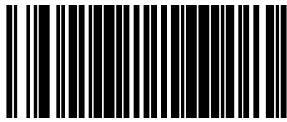

## MSI Check Character Calculation

Enables/disables calculation and verification of optional MSI check characters.



**NOTE: If check character calculation is disabled, the risk is increased that a misread can occur. When disabled, any check characters in a bar code are treated as data characters.**

To set this feature:

1. Scan the ENTER/EXIT Programming Mode bar code.
2. Scan either the enable or disable bar code below. You'll need to cover any unused bar codes on this and the facing page to ensure that the scanner reads only the bar code you intend to scan.
3. Complete the programming sequence by scanning the ENTER/EXIT Programming Mode bar code.



MSI Check Character Calculation = Disable



★ MSI Check Character Calculation = Enable

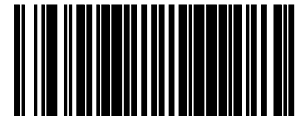

## MSI Number of Check Characters

Specifies number of MSI check characters to be calculated and verified.



**NOTE: Check characters are always modulus 10.**

To set this feature:

1. Scan the ENTER/EXIT Programming Mode bar code.
2. Scan the bar code below representing the desired number of MSI check characters to be calculated and verified. You'll need to cover any unused bar codes on this and the facing page to ensure that the scanner reads only the bar code you intend to scan.
3. Complete the programming sequence by scanning the ENTER/EXIT Programming Mode bar code.



★ MSI Number of Check Characters = 1



MSI Number of Check Characters = 2

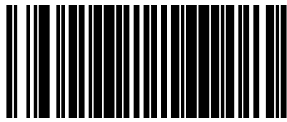

## MSI Check Character Transmission

Enables/disables transmission of optional MSI check characters.



**NOTE: This feature applies only when MSI Check Character Calculation is enabled. This item is ignored when the advanced feature, Full Label Edit, is enabled.**

To set this feature:

1. Scan the ENTER/EXIT Programming Mode bar code.
2. Scan either the enable or disable bar code below. You'll need to cover any unused bar codes on this and the facing page to ensure that the scanner reads only the bar code you intend to scan.
3. Complete the programming sequence by scanning the ENTER/EXIT Programming Mode bar code.



MSI Check Character Transmission = Disable



★ MSI Check Character Transmission = Enable

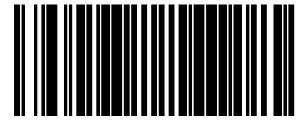

## MSI Minimum Read

This feature specifies the minimum number of consecutive MSI decodes before is accepted as good read.

To set this feature:

1. Scan the ENTER/EXIT Programming Mode bar code.
2. Scan your selection from the bar codes below. You'll need to cover any unused bar codes on this and the facing page to ensure that the scanner reads only the bar code you intend to scan.
3. Complete the programming sequence by scanning the ENTER/EXIT Programming Mode bar code.



★ MSI Minimum Read = 1



MSI Minimum Read = 2



MSI Minimum Read = 3



MSI Minimum Read = 4

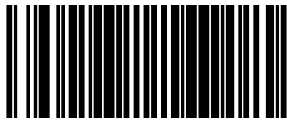

## MSI Correlation

Enables/disables character correlation for MSI.

To set this feature:

1. Scan the ENTER/EXIT Programming Mode bar code.
2. Scan either the enable or disable bar code below. You'll need to cover any unused bar codes on this and the facing page to ensure that the scanner reads only the bar code you intend to scan.
3. Complete the programming sequence by scanning the ENTER/EXIT Programming Mode bar code.



★ MSI Correlation = Disable



MSI Correlation = Enable



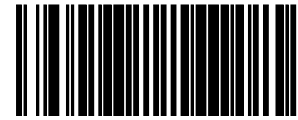

## MSI Length Control

This feature specifies whether variable-length or fixed-length decoding will be set for MSI.

To set this feature:

1. Scan the ENTER/EXIT Programming Mode bar code.
2. Scan your selection from the bar codes below. You'll need to cover any unused bar codes on this and the facing page to ensure that the scanner reads only the bar code you intend to scan.
3. Complete the programming sequence by scanning the ENTER/EXIT Programming Mode bar code.



★ MSI Length Control = Variable Length



MSI Length Control = Fixed Length

## MSI Length 1

If MSI Length Control is set to Fixed-Length decoding, this feature specifies MSI first fixed length. If MSI Length Control is set to Variable-Length decoding, this feature specifies the minimum label length.

To set this feature:

1. Scan the ENTER/EXIT Programming Mode bar code.
2. Scan the bar code, [Set MSI Length 1](#) below. You'll need to cover any unused bar codes on this and the facing page to ensure that the scanner reads only the bar code you intend to scan.
3. Scan the appropriate digits from the [Alpha-Numeric Keypad in Appendix C](#) that represent the desired label length. The selectable range for this option is 4 to 16. Pad all single digit numbers with a leading zero to yield a two-digit entry (04-16).
4. Complete the programming sequence by scanning the ENTER/EXIT Programming Mode bar code.

★ Default setting for this feature = 04



Set MSI Length 1

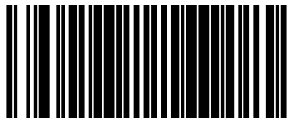

## MSI Length 2

If MSI Length Control is set to Fixed-Length decoding, this feature specifies MSI second fixed length. If MSI Length Control is set to Variable-Length decoding, this feature specifies the maximum label length.



**NOTE: When in Fixed Length mode, if Length 2 is set to the value 00 (zero), then only Length 1 will apply.**

To set this feature:

1. Scan the ENTER/EXIT Programming Mode bar code.
2. Scan the bar code, [Set MSI Length 2](#) below. You'll need to cover any unused bar codes on this and the facing page to ensure that the scanner reads only the bar code you intend to scan.
3. Scan the appropriate digits from the [Alpha-Numeric Keypad in Appendix C](#) that represent the desired label length. The selectable range for this option is 00 (meaning ignore this length), or 04 to 16. Pad all single digit numbers with a leading zero to yield a two-digit entry (00, 04-16).
4. Complete the programming sequence by scanning the ENTER/EXIT Programming Mode bar code.

★ Default setting for this feature = 10 (length = 16)



Set MSI Length 2

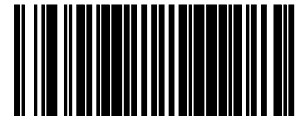

## MSI Stitching

Enables/disables stitching for MSI labels. When parts of an MSI bar code are presented to the scanner with this feature enabled, the bar code parts will be assembled by the scanner's software, and the data will be decoded if all bar code proofing requirements are met.

To set this feature:

1. Scan the ENTER/EXIT Programming Mode bar code.
2. Scan your selection from the bar codes below. You'll need to cover any unused bar codes on this and the facing page to ensure that the scanner reads only the bar code you intend to scan.
3. Complete the programming sequence by scanning the ENTER/EXIT Programming Mode bar code.



★ MSI Stitching = Disable



MSI Stitching = Enable

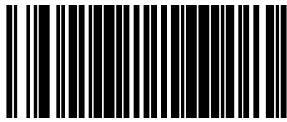

## STANDARD 2 OF 5

### Standard 2 of 5 Enable

Enables/disables the ability of the scanner to decode Standard 2 of 5 labels.

To set this feature:

1. Scan the ENTER/EXIT Programming Mode bar code.
2. Scan either the enable or disable bar code below. You'll need to cover any unused bar codes on this and the facing page to ensure that the scanner reads only the bar code you intend to scan.
3. Complete the programming sequence by scanning the ENTER/EXIT Programming Mode bar code.



★ Standard 2 of 5 = Disable



Standard 2 of 5 = Enable

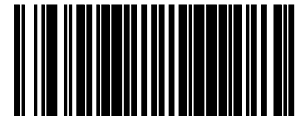

## Standard 2 of 5 Check Character Calculation

Enables/disables calculation and verification of an optional Standard 2 of 5 check character.



**NOTE: If check character calculation is disabled, the risk is increased that a misread can occur. When disabled, any check character in a bar code is treated as data character.**

To set this feature:

1. Scan the ENTER/EXIT Programming Mode bar code.
2. Scan either the enable or disable bar code below. You'll need to cover any unused bar codes on this and the facing page to ensure that the scanner reads only the bar code you intend to scan.
3. Complete the programming sequence by scanning the ENTER/EXIT Programming Mode bar code.



★ Standard 2 of 5 Check Character Calculation = Disable



Standard 2 of 5 Check Character Calculation = Enable

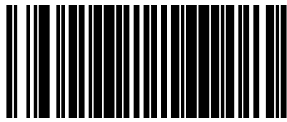

## Standard 2 of 5 Check Character Transmission

Enables/disables transmission of an optional Standard 2 of 5 check character.



**NOTE: This feature applies only when Standard 2 of 5 Check Character Calculation is enabled. This item is ignored when the advanced feature, Full Label Edit, is enabled.**

To set this feature:

1. Scan the ENTER/EXIT Programming Mode bar code.
2. Scan either the enable or disable bar code below. You'll need to cover any unused bar codes on this and the facing page to ensure that the scanner reads only the bar code you intend to scan.
3. Complete the programming sequence by scanning the ENTER/EXIT Programming Mode bar code.



Standard 2 of 5 Check Character Transmission = Disable



★ Standard 2 of 5 Check Character Transmission = Enable

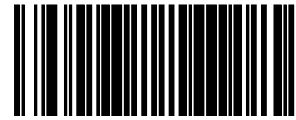

## Standard 2 of 5 Minimum Read

This feature specifies the minimum number of consecutive Standard 2 of 5 decodes before is accepted as good read.

To set this feature:

1. Scan the ENTER/EXIT Programming Mode bar code.
2. Scan your selection from the bar codes below. You'll need to cover any unused bar codes on this and the facing page to ensure that the scanner reads only the bar code you intend to scan.
3. Complete the programming sequence by scanning the ENTER/EXIT Programming Mode bar code.



★ Standard 2 of 5 Minimum Read = 1



Standard 2 of 5 Minimum Read = 2



Standard 2 of 5 Minimum Read = 3



Standard 2 of 5 Minimum Read = 4

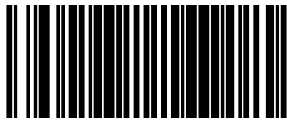

## Standard 2 of 5 Correlation

Enables/disables character correlation for Standard 2 of 5.

To set this feature:

1. Scan the ENTER/EXIT Programming Mode bar code.
2. Scan either the enable or disable bar code below. You'll need to cover any unused bar codes on this and the facing page to ensure that the scanner reads only the bar code you intend to scan.
3. Complete the programming sequence by scanning the ENTER/EXIT Programming Mode bar code.



★ Standard 2 of 5 Correlation = Disable



Standard 2 of 5 Correlation = Enable



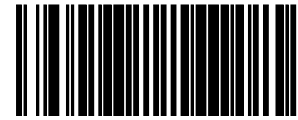

## Standard 2 of 5 Length Control

This feature specifies whether variable-length or fixed-length decoding will be set for Standard 2 of 5.

To set this feature:

1. Scan the ENTER/EXIT Programming Mode bar code.
2. Scan your selection from the bar codes below. You'll need to cover any unused bar codes on this and the facing page to ensure that the scanner reads only the bar code you intend to scan.
3. Complete the programming sequence by scanning the ENTER/EXIT Programming Mode bar code.



★ Standard 2 of 5 Length Control = Variable Length



Standard 2 of 5 Length Control = Fixed Length

## Standard 2 of 5 Length 1

If Standard 2 of 5 Length Control is set to Fixed-Length decoding, this feature specifies Standard 2 of 5 first fixed length. If Standard 2 of 5 Length Control is set to Variable-Length decoding, this feature specifies the minimum label length.

To set this feature:

1. Scan the ENTER/EXIT Programming Mode bar code.
2. Scan the bar code, [Set Standard 2 of 5 Length 1](#) below. You'll need to cover any unused bar codes on this and the facing page to ensure that the scanner reads only the bar code you intend to scan.
3. Scan the appropriate digits from the [Alpha-Numeric Keypad in Appendix C](#) that represent the desired label length. The selectable range for this option is 1 to 50. Pad all single digit numbers with a leading zero to yield a two-digit entry (01-50).
4. Complete the programming sequence by scanning the ENTER/EXIT Programming Mode bar code.

★ Default setting for this feature = 08



Set Standard 2 of 5 Length 1

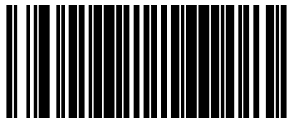

## Standard 2 of 5 Length 2

If Standard 2 of 5 Length Control is set to Fixed-Length decoding, this feature specifies Standard 2 of 5 second fixed length. If Standard 2 of 5 Length Control is set to Variable-Length decoding, this feature specifies the maximum label length.



**NOTE: When in Fixed Length mode, if Length 2 is set to the value of 00 (zero), then only Length 1 will apply.**

To set this feature:

1. Scan the ENTER/EXIT Programming Mode bar code.
2. Scan the bar code, [Set Standard 2 of 5 Length 2](#) below. You'll need to cover any unused bar codes on this and the facing page to ensure that the scanner reads only the bar code you intend to scan.
3. Scan the appropriate digits from the [Alpha-Numeric Keypad in Appendix C](#) that represent the desired label length. The selectable range for this option is 1 to 50. Pad all single digit numbers with a leading zero to yield a two-digit entry (01-50).
4. Complete the programming sequence by scanning the ENTER/EXIT Programming Mode bar code.

★ Default setting for this feature = 32 (length = 50)



Set Standard 2 of 5 Length 2

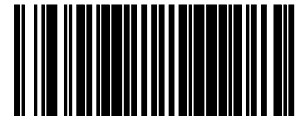

## Standard 2 of 5 Stitching

Enables/disables stitching for Standard 2 of 5 labels. When parts of a Standard 2 of 5 bar code are presented to the scanner with this feature enabled, the bar code parts will be assembled by the scanner's software, and the data will be decoded if all bar code proofing requirements are met.



**NOTE: This applies when Standard 2 of 5 Length Control is set to fixed-length decoding.**

To set this feature:

1. Scan the ENTER/EXIT Programming Mode bar code.
2. Scan your selection from the bar codes below. You'll need to cover any unused bar codes on this and the facing page to ensure that the scanner reads only the bar code you intend to scan.
3. Complete the programming sequence by scanning the ENTER/EXIT Programming Mode bar code.



★ Standard 2 of 5 Stitching = Disable



Standard 2 of 5 Stitching = Enable

# 2D SYMBOLOGIES/BAR CODES

## 2D Codes



**NOTE: If the scanner's interface type must be changed, always be sure that interface configuration is the FIRST item scanned during a programming session. (Selecting an interface type resets ALL other configuration items — including symbology programming — to the factory default for that interface type.)**

The following pages contain configuration information concerning the various 2D bar code types the scanner supports.

SECTION CONTENTS
<b>DATA MATRIX</b> starting on page 227
<b>PDF 417</b> starting on page 231
<b>MICRO PDF 417</b> starting on page 235
<b>QR CODE</b> starting on page 239
<b>MICRO QR CODE</b> starting on page 244
<b>AZTEC CODE</b> starting on page 247

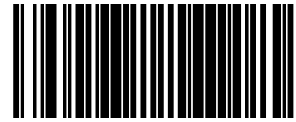

## DATA MATRIX

### Data Matrix Enable

Enables/disables the ability of the scanner to decode Data Matrix labels.

To set this feature:

1. Scan the Enter/Exit Programming Mode bar code.
2. Scan either the enable or disable bar code below. You'll need to cover any unused bar codes on this and the facing page to ensure that the scanner reads only the bar code you intend to scan.
3. Complete the programming sequence by scanning the Enter/Exit Programming Mode bar code.



★ Data Matrix = Disable



Data Matrix = Enable

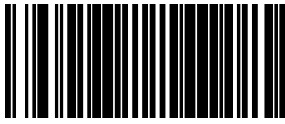

## Data Matrix Length Control

**Fixed Length Decoding:** When fixed length decoding is enabled, the scanner will decode a bar code if the label length matches one of the configurable fixed lengths.

**Variable Length Decoding:** When variable length decoding is enabled, the scanner will decode a bar code if the label length falls in the range of the configurable minimum and maximum length.

Configuring Fixed Length Decoding:

1. Scan the ENTER/EXIT Programming Mode bar code.
2. Scan the Fixed Length Decoding bar code.
3. Scan the ENTER/EXIT Programming Mode bar code.
4. Set Length 1 to the first fixed length using the [Data Matrix Length 1, Length 2 Programming Instructions](#) that follow this page.
5. Set Length 2 to the second fixed length (or to '0000' if there is only one fixed length) using the [Data Matrix Length 1, Length 2 Programming Instructions](#).

### Configuring Variable Length Decoding:

1. Scan the ENTER/EXIT Programming Mode bar code.
2. Scan the Variable Length Decoding bar code.
3. Scan the ENTER/EXIT Programming Mode bar code.
4. Set Length 1 to the minimum length using the [Data Matrix Length 1, Length 2 Programming Instructions](#) that follow this page.
5. Set Length 2 to the maximum length using the [Data Matrix Length 1, Length 2 Programming Instructions](#).



★ Data Matrix Length Control = Variable Length



Data Matrix Length Control = Fixed Length

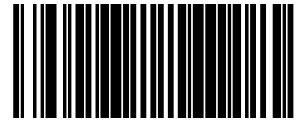

## Data Matrix Length 1, Length 2 Programming Instructions

If Data Matrix Length Control is set to Fixed-Length decoding, this feature specifies Data Matrix first fixed length. If Data Matrix Length Control is set to Variable-Length decoding, this feature specifies the minimum label length.



**NOTE: For Data Matrix bar codes, only the data characters are included in the length calculations.**

To set this feature:

1. Scan the ENTER/EXIT Programming Mode bar code.
2. Scan the bar code, [Set Data Matrix Length 1](#) or [Set Data Matrix Length 2](#) below. You'll need to cover any unused bar codes on this and the facing page to ensure that the scanner reads only the bar code you intend to scan.
3. Scan the appropriate digits from the [Alpha-Numeric Keypad in Appendix C](#) that represent the desired label length. The selectable range for this option is 0001 to 3116. Pad all numbers with leading zeros to yield a four-digit entry (0001-3116).
4. Complete the programming sequence by scanning the ENTER/EXIT Programming Mode bar code.



Set Data Matrix Length 1

★ Default setting for this feature = 0001



Set Data Matrix Length 2

★ Default setting for this feature = 0320 (length = 800)

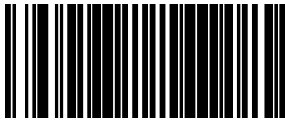

## GS1 Datamatrix Enable

Enables/disables the ability of the scanner to decode GS1 Datamatrix labels.

To set this feature:

1. Scan the Enter/Exit Programming Mode bar code.
2. Scan either the enable or disable bar code below. You'll need to cover any unused bar codes on this and the facing page to ensure that the scanner reads only the bar code you intend to scan.
3. Complete the programming sequence by scanning the Enter/Exit Programming Mode bar code.



★ GS1 Datamatrix disabled



GS1 Datamatrix enabled



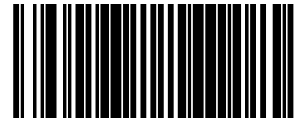

## PDF 417

### PDF 417 Enable

Enables the processing of PDF417 labels.

To set this feature:

1. Scan the Enter/Exit Programming Mode bar code.
2. Scan either the enable or disable bar code below. You'll need to cover any unused bar codes on this and the facing page to ensure that the scanner reads only the bar code you intend to scan.
3. Complete the programming sequence by scanning the Enter/Exit Programming Mode bar code.



★ PDF 417 = Disable



PDF 417 = Enable

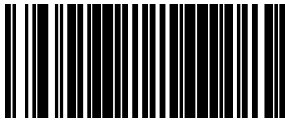

## PDF 417 Length Control

**Fixed Length Decoding:** When fixed length decoding is enabled, the scanner will decode a bar code if the label length matches one of the configurable fixed lengths.

**Variable Length Decoding:** When variable length decoding is enabled, the scanner will decode a bar code if the label length falls in the range of the configurable minimum and maximum length.

Configuring Fixed Length Decoding:

1. Scan the ENTER/EXIT Programming Mode bar code.
2. Scan the Fixed Length Decoding bar code.
3. Scan the ENTER/EXIT Programming Mode bar code.
4. Set Length 1 to the first fixed length using the [PDF 417 Length 1, Length 2 Programming Instructions](#) that follow this page.
5. Set Length 2 to the second fixed length (or to '0000' if there is only one fixed length) using the [PDF 417 Length 1, Length 2 Programming Instructions](#).

### Configuring Variable Length Decoding:

1. Scan the ENTER/EXIT Programming Mode bar code.
2. Scan the Variable Length Decoding bar code.
3. Scan the ENTER/EXIT Programming Mode bar code.
4. Set Length 1 to the minimum length using the [PDF 417 Length 1, Length 2 Programming Instructions](#) that follow this page.
5. Set Length 2 to the maximum length using the [PDF 417 Length 1, Length 2 Programming Instructions](#).



★ PDF 417 Length Control = Variable Length



PDF 417 Length Control = Fixed Length

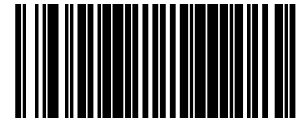

## PDF 417 Length 1, Length 2 Programming Instructions

If PDF417 Length Control is set to Fixed-Length decoding, this feature specifies PDF417 first fixed length. If PDF417 Length Control is set to Variable-Length decoding, this feature specifies the minimum label length.



**NOTE: This tag is only valid for units with a model id that supports PDF.**

**Length 1 is the minimum label length if in variable length mode, or the first fixed length if in fixed length mode. Length 2 is the maximum label length if in variable length mode, or the second fixed length if in fixed length mode. Length includes the bar code's data characters only. Any value > 2710 will be considered to be 2710.**

To set this feature:

1. Scan the ENTER/EXIT Programming Mode bar code.
2. Scan the bar code, [Set PDF 417 Length 1](#) or [Set PDF 417 Length 2](#) below. You'll need to cover any unused bar codes on this and the facing page to ensure that the scanner reads only the bar code you intend to scan.
3. Scan the appropriate digits from the [Alpha-Numeric Keypad in Appendix C](#) that represent the desired label length. The selectable range for this option is 0001 to 2710. Pad all numbers with leading zeros to yield a four-digit entry (0001-2710).
4. Complete the programming sequence by scanning the ENTER/EXIT Programming Mode bar code.



Set PDF 417 Length 1

★ Default setting for this feature = 0001



Set PDF 417 Length 2

★ Default setting for this feature = 0A96 (length = 2710)

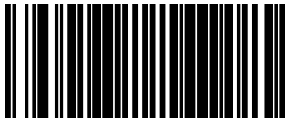

## PDF 417 Read Option

This feature specifies an additional read control option for PDF 417 bar codes.

To set this feature:

1. Scan the Enter/Exit Programming Mode bar code.
2. Scan either the enable or disable bar code below. You'll need to cover any unused bar codes on this and the facing page to ensure that the scanner reads only the bar code you intend to scan.
3. Complete the programming sequence by scanning the Enter/Exit Programming Mode bar code.



★ PDF 417 Read Option = None



PDF 417 Read Option = Turn Off Codeword  
Length Checking

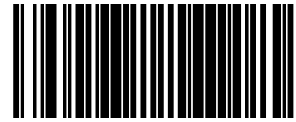

## MICRO PDF 417

### Micro PDF 417 Enable

Enables/disables the ability of the scanner to decode Micro PDF 417 labels.

To set this feature:

1. Scan the Enter/Exit Programming Mode bar code.
2. Scan either the enable or disable bar code below. You'll need to cover any unused bar codes on this and the facing page to ensure that the scanner reads only the bar code you intend to scan.
3. Complete the programming sequence by scanning the Enter/Exit Programming Mode bar code.



★ Micro PDF 417 = Disable



Micro PDF 417 = Enable

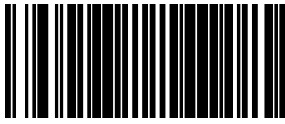

## Micro PDF 417 Length Control

**Fixed Length Decoding:** When fixed length decoding is enabled, the scanner will decode a bar code if the label length matches one of the configurable fixed lengths.

**Variable Length Decoding:** When variable length decoding is enabled, the scanner will decode a bar code if the label length falls in the range of the configurable minimum and maximum length.

Configuring Fixed Length Decoding:

1. Scan the ENTER/EXIT Programming Mode bar code.
2. Scan the Fixed Length Decoding bar code.
3. Scan the ENTER/EXIT Programming Mode bar code.
4. Set Length 1 to the first fixed length using the [Micro PDF 417 Length 1, Length 2 Programming Instructions](#) that follow this page.
5. Set Length 2 to the second fixed length (or to '0000' if there is only one fixed length) using the [Micro PDF 417 Length 1, Length 2 Programming Instructions](#).

### Configuring Variable Length Decoding:

1. Scan the ENTER/EXIT Programming Mode bar code.
2. Scan the Variable Length Decoding bar code.
3. Scan the ENTER/EXIT Programming Mode bar code.
4. Set Length 1 to the minimum length using the [Micro PDF 417 Length 1, Length 2 Programming Instructions](#) that follow this page.
5. Set Length 2 to the maximum length using the [Micro PDF 417 Length 1, Length 2 Programming Instructions](#).



★ Micro PDF 417 Length Control = Variable Length



Micro PDF 417 Length Control = Fixed Length

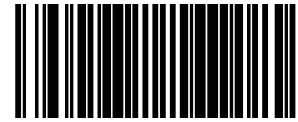

## Micro PDF 417 Length 1, Length 2 Programming Instructions

If Micro PDF 417 Length Control is set to Fixed-Length decoding, this feature specifies Micro PDF 417 first fixed length. If Micro PDF 417 Length Control is set to Variable-Length decoding, this feature specifies the minimum label length.



**NOTE: This tag is only valid for units with a model ID that supports PDF.**

**Length 1 is the minimum label length if in variable length mode, or the first fixed length if in fixed length mode. Length 2 is the maximum label length if in variable length mode, or the second fixed length if in fixed length mode. Length includes the bar code's data characters only. Any value > 0366 will be considered to be 0366.**

To set this feature:

1. Scan the ENTER/EXIT Programming Mode bar code.
2. Scan the bar code, [Set Micro PDF 417 Length 1](#) or [Set Micro PDF 417 Length 2](#) below. You'll need to cover any unused bar codes on this and the facing page to ensure that the scanner reads only the bar code you intend to scan.
3. Scan the appropriate digits from the [Alpha-Numeric Keypad in Appendix C](#) that represent the desired label length. The selectable range for this option is 0001 to 0366. Pad all numbers with leading zeros to yield a four-digit entry (0001-0366).
4. Complete the programming sequence by scanning the ENTER/EXIT Programming Mode bar code.



Set Micro PDF 417 Length 1

★ Default setting for this feature = 0001



Set Micro PDF 417 Length 2

★ Default setting for this feature = 016E (length = 366)

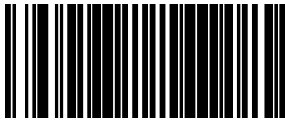

## Micro PDF 417 128 Emulation

This feature specifies which AIM ID to use for Micro PDF 417 labels when performing Code 128 or EAN 128 emulation.

To set this feature:

1. Scan the Enter/Exit Programming Mode bar code.
2. Scan the bar code below for the desired setting. You'll need to cover any unused bar codes on this and the facing page to ensure that the scanner reads only the bar code you intend to scan.
3. Complete the programming sequence by scanning the Enter/Exit Programming Mode bar code.



★ Micro PDF 417 128 Emulation = Micro PDF AIM ID and label type when emulating EAN128 or Code 128

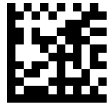

Micro PDF 417 128 Emulation = Code 128 / EAN128  
AIM ID and label type when emulating EAN128 or Code  
128



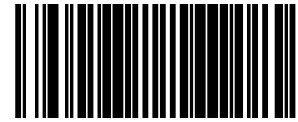

## QR CODE

### QR Code Enable

Enables/disables the ability of the scanner to decode QR Code labels.

To set this feature:

1. Scan the Enter/Exit Programming Mode bar code.
2. Scan either the enable or disable bar code below. You'll need to cover any unused bar codes on this and the facing page to ensure that the scanner reads only the bar code you intend to scan.
3. Complete the programming sequence by scanning the Enter/Exit Programming Mode bar code.



★ QR Code = Disable



QR Code = Enable

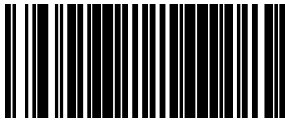

## QR Code Length Control

**Fixed Length Decoding:** When fixed length decoding is enabled, the scanner will decode a bar code if the label length matches one of the configurable fixed lengths.

**Variable Length Decoding:** When variable length decoding is enabled, the scanner will decode a bar code if the label length falls in the range of the configurable minimum and maximum length.

Configuring Fixed Length Decoding:

1. Scan the ENTER/EXIT Programming Mode bar code.
2. Scan the Fixed Length Decoding bar code.
3. Scan the ENTER/EXIT Programming Mode bar code.
4. Set Length 1 to the first fixed length using the [QR Code Length 1, Length 2 Programming Instructions](#) that follow this page.
5. Set Length 2 to the second fixed length (or to '0000' if there is only one fixed length) using the [QR Code Length 1, Length 2 Programming Instructions](#).

### Configuring Variable Length Decoding:

1. Scan the ENTER/EXIT Programming Mode bar code.
2. Scan the Variable Length Decoding bar code.
3. Scan the ENTER/EXIT Programming Mode bar code.
4. Set Length 1 to the minimum length using the [QR Code Length 1, Length 2 Programming Instructions](#) that follow this page.
5. Set Length 2 to the maximum length using the [QR Code Length 1, Length 2 Programming Instructions](#).



★ QR Code Length Control = Variable Length



QR Code Length Control = Fixed Length

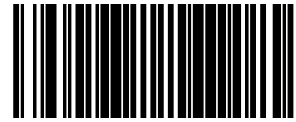

## QR Code Length 1, Length 2 Programming Instructions

If QR Code Length Control is set to Fixed-Length decoding, this feature specifies QR Code first fixed length. If QR Code Length Control is set to Variable-Length decoding, this feature specifies the minimum label length.



**NOTE: Length 1 is the minimum label length if in variable length mode, or the first fixed length if in fixed length mode. Length 2 is the maximum label length if in variable length mode, or the second fixed length if in fixed length mode. Length includes the bar code's data characters only. Any value > 2710 will be considered to be 2710.**

To set this feature:

1. Scan the ENTER/EXIT Programming Mode bar code.
2. Scan the bar code, [Set QR Code Length 1](#) or [Set QR Code Length 2](#) below. You'll need to cover any unused bar codes on this and the facing page to ensure that the scanner reads only the bar code you intend to scan.
3. Scan the appropriate digits from the [Alpha-Numeric Keypad in Appendix C](#) that represent the desired label length. The selectable range for this option is 0001 to 2710. Pad all numbers with leading zeros to yield a four-digit entry (001-02710).
4. Complete the programming sequence by scanning the ENTER/EXIT Programming Mode bar code.



Set QR Code Length 1

★ Default setting for this feature = 0001

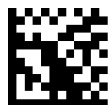

Set QR Code Length 2

★ Default setting for this feature = 0A96 (length = 2710)

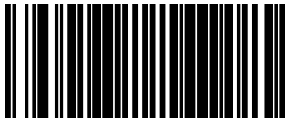

## QR Code URL Link Enable

Enables/Disables the decoding of QR codes with a URL link on imagers other than the optional Customer Service Scanner (CSS).

To set this feature:

1. Scan the Enter/Exit Programming Mode bar code.
2. Scan either the enable or disable bar code below. You'll need to cover any unused bar codes on this and the facing page to ensure that the scanner reads only the bar code you intend to scan.
3. Complete the programming sequence by scanning the Enter/Exit Programming Mode bar code.



★ QR Code URL Link = Disable



QR Code URL Link = Enable

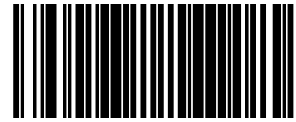

## GS1 QR CODE ENABLE

This feature controls the ability of the scanner to decode GS1 QR Code labels.

To set this feature:

1. Scan the Enter/Exit Programming Mode bar code.
2. Scan either the enable or disable bar code below. You'll need to cover any unused bar codes on this and the facing page to ensure that the scanner reads only the bar code you intend to scan.
3. Complete the programming sequence by scanning the Enter/Exit Programming Mode bar code.



★ GS1 QR Code = Disable

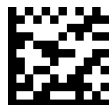

GS1 QR Code = Enable

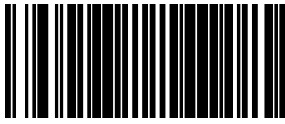

## MICRO QR CODE

### Micro QR Code Enable

Enables/disables the ability of the scanner to decode Micro QRCode labels.

To set this feature:

1. Scan the Enter/Exit Programming Mode bar code.
2. Scan either the enable or disable bar code below. You'll need to cover any unused bar codes on this and the facing page to ensure that the scanner reads only the bar code you intend to scan.
3. Complete the programming sequence by scanning the Enter/Exit Programming Mode bar code.



★ Micro QR Code = Disable



Micro QR Code = Enable

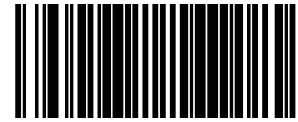

## Micro QR Code Length Control

**Fixed Length Decoding:** When fixed length decoding is enabled, the scanner will decode a bar code if the label length matches one of the configurable fixed lengths.

**Variable Length Decoding:** When variable length decoding is enabled, the scanner will decode a bar code if the label length falls in the range of the configurable minimum and maximum length.

Configuring Fixed Length Decoding:

1. Scan the ENTER/EXIT Programming Mode bar code.
2. Scan the Fixed Length Decoding bar code.
3. Scan the ENTER/EXIT Programming Mode bar code.
4. Set Length 1 to the first fixed length using the [Micro QR Code Length 1, Length 2 Programming Instructions](#) that follow this page.
5. Set Length 2 to the second fixed length (or to '0000' if there is only one fixed length) using the [Micro QR Code Length 1, Length 2 Programming Instructions](#).

### Configuring Variable Length Decoding:

1. Scan the ENTER/EXIT Programming Mode bar code.
2. Scan the Variable Length Decoding bar code.
3. Scan the ENTER/EXIT Programming Mode bar code.
4. Set Length 1 to the minimum length using the [Micro QR Code Length 1, Length 2 Programming Instructions](#) that follow this page.
5. Set Length 2 to the maximum length using the [Micro QR Code Length 1, Length 2 Programming Instructions](#).



★ Micro QR Code Length Control = Variable Length



Micro QR Code Length Control = Fixed Length

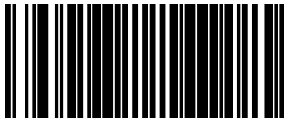

## Micro QR Code Length 1, Length 2 Programming Instructions

If Micro QR Code Length Control is set to Fixed-Length decoding, this feature specifies Micro QR Code first fixed length. If Micro QR Code Length Control is set to Variable-Length decoding, this feature specifies the minimum label length.



**NOTE: Length 1 is the minimum label length if in variable length mode, or the first fixed length if in fixed length mode. Length 2 is the maximum label length if in variable length mode, or the second fixed length if in fixed length mode. Length includes the bar code's data characters only. Any value > 3700 will be considered to be 3700.**

To set this feature:

1. Scan the ENTER/EXIT Programming Mode bar code.
2. Scan the bar code, [Set Aztec Length 1](#) or [Set Micro QR Code Length 2](#) below. You'll need to cover any unused bar codes on this and the facing page to ensure that the scanner reads only the bar code you intend to scan.
3. Scan the appropriate digits from the [Alpha-Numeric Keypad in Appendix C](#) that represent the desired label length. The selectable range for this option is 0001 to 3700. Pad all numbers with leading zeros to yield a four-digit entry (0001-3700).
4. Complete the programming sequence by scanning the ENTER/EXIT Programming Mode bar code.



Set Micro QR Code Length 1

★ Default setting for this feature = 0001



Set Micro QR Code Length 2

★ Default setting for this feature = 0E74 (length = 3700)



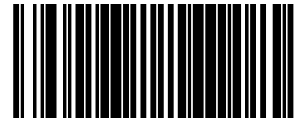

## AZTEC CODE

### Aztec Enable

Enables/disables the ability of the scanner to decode Aztec labels.

To set this feature:

1. Scan the Enter/Exit Programming Mode bar code.
2. Scan either the enable or disable bar code below. You'll need to cover any unused bar codes on this and the facing page to ensure that the scanner reads only the bar code you intend to scan.
3. Complete the programming sequence by scanning the Enter/Exit Programming Mode bar code.



★ Aztec = Disable



Aztec = Enable

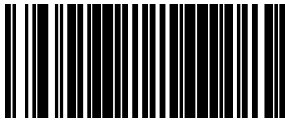

## Aztec Length Control

**Fixed Length Decoding:** When fixed length decoding is enabled, the scanner will decode a bar code if the label length matches one of the configurable fixed lengths.

**Variable Length Decoding:** When variable length decoding is enabled, the scanner will decode a qr code if the label length falls in the range of the configurable minimum and maximum length.

Configuring Fixed Length Decoding:

1. Scan the ENTER/EXIT Programming Mode bar code.
2. Scan the Fixed Length Decoding bar code.
3. Scan the ENTER/EXIT Programming Mode bar code.
4. Set Length 1 to the first fixed length using the [Aztec Length 1, Length 2 Programming Instructions](#) that follow this page.
5. Set Length 2 to the second fixed length (or to '0000' if there is only one fixed length) using the [Aztec Length 1, Length 2 Programming Instructions](#).

### Configuring Variable Length Decoding:

1. Scan the ENTER/EXIT Programming Mode bar code.
2. Scan the Variable Length Decoding bar code.
3. Scan the ENTER/EXIT Programming Mode bar code.
4. Set Length 1 to the minimum length using the [Aztec Length 1, Length 2 Programming Instructions](#) that follow this page.
5. Set Length 2 to the maximum length using the [Aztec Length 1, Length 2 Programming Instructions](#).



★ Aztec Length Control = Variable Length



Aztec Length Control = Fixed Length

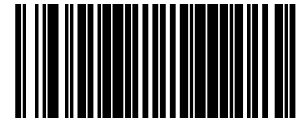

## Aztec Length 1, Length 2 Programming Instructions

If Aztec Length Control is set to Fixed-Length decoding, this feature specifies Aztec first fixed length. If Aztec Length Control is set to Variable-Length decoding, this feature specifies the minimum label length.



**NOTE: Length 1 is the minimum label length if in variable length mode, or the first fixed length if in fixed length mode. Length 2 is the maximum label length if in variable length mode, or the second fixed length if in fixed length mode. Length includes the bar code's data characters only. Any value > 3700 will be considered to be 3700.**

To set this feature:

1. Scan the ENTER/EXIT Programming Mode bar code.
2. Scan the bar code, [Set Aztec Length 1](#) or [Set Aztec Length 2](#) below. You'll need to cover any unused bar codes on this and the facing page to ensure that the scanner reads only the bar code you intend to scan.
3. Scan the appropriate digits from the [Alpha-Numeric Keypad in Appendix C](#) that represent the desired label length. The selectable range for this option is 0001 to 3700. Pad all numbers with leading zeros to yield a four-digit entry (0001-3700).
4. Complete the programming sequence by scanning the ENTER/EXIT Programming Mode bar code.



Set Aztec Length 1

★ Default setting for this feature = 0001



Set Aztec Length 2

★ Default setting for this feature = 0E74 (length = 3700)

# CHAPTER 3

## REFERENCES

---

This section contains explanations and examples of selected bar code features. See the programming sections for the actual bar code labels used to configure the reader.

SECTION CONTENTS
<b>GLOBAL PREFIX/SUFFIX</b> <a href="#">starting on page 251</a>
<b>LABEL ID</b> <a href="#">starting on page 252</a>
<b>LENGTH CONTROL</b> <a href="#">starting on page 253</a>

## GLOBAL PREFIX/SUFFIX

Up to 20 ASCII characters may be added as a prefix (in a position before the bar code data) and/or as a suffix (in a position following the bar code data) as indicated in Figure 10.

Figure 10. Prefix and Suffix Positions

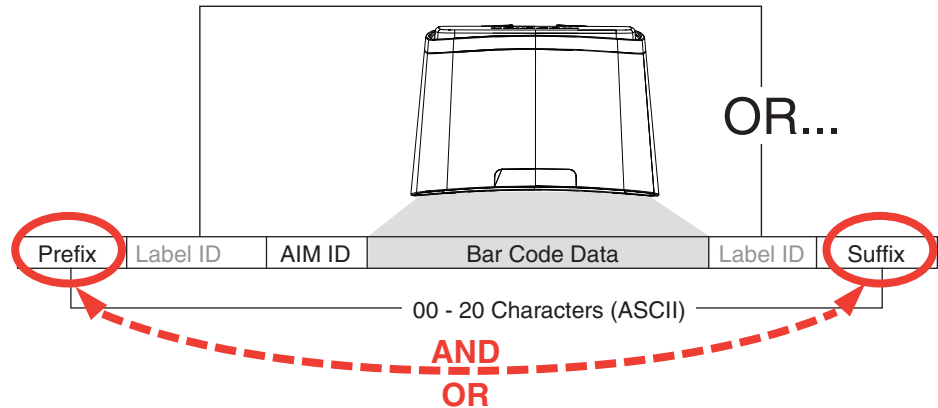

### Example: Setting a Prefix

In this example, we'll set a prefix for all symbologies.

1. Determine which ASCII character(s) are to be added to scanned bar code data. In this example, we'll add a dollar sign ('\$') as a prefix.
2. Scan the Enter/Exit Programming Mode bar code.
3. Scan the SET PREFIX bar code.
4. Reference the [ASCII Character Set](#) on the inside back cover of this manual, to find the hex value assigned to the desired character. The corresponding hex number for the '\$' character is 24. To enter this selection code, scan the '2' and '4' bar codes from [Appendix C, Alpha-Numeric Keypad](#).
5. Scan the END bar code once to finish the string, then scan END again to exit Programming Mode.



**NOTE: If all 20 characters will be used in the prefix or suffix, do not scan the END bar code to finish the string. It is done automatically.**

6. The resulting message string would appear as follows:  
Scanned bar code data:12345  
Resulting message string output: \$12345

## LABEL ID

A Label ID is used to identify a bar code (symbology) type. See [Appendix D, Factory Default Settings](#), for a listing for common symbologies. It can be appended previous to or following the transmitted bar code data depending upon how this option is enabled. This feature provides options for configuring custom Label IDs individually per symbology. If you wish to program the scanner to always include an industry standard label identifier for ALL symbology types, see the feature, [AIM ID](#) on page 82.

The Label ID is a customizable code of up to three ASCII characters (each of which are 00-7F) followed by a control character (00-01). This control character, when set to zero, does nothing. When set to one, it appends the symbology's AIM ID to the Label ID.



**NOTE: When the control character is set to 01 for UPC-A and UPC-E, it expands the label to EAN-13 and thus follows the EAN-13 Label ID settings.**

To configure a Label ID:

1. Scan the Enter/Exit Programming Mode bar code.
2. Select Label ID position as either BEFORE or AFTER by scanning the appropriate bar code.
3. Scan a bar code to select the symbology for which you wish to configure a custom Label ID.
4. Determine the desired character(s) (you may choose up to three) which will represent the Label ID for the selected symbology. Next, turn to the [ASCII Character Set](#) on the inside back cover of this manual and find the equivalent hex digits associated with your choice of Label ID. For example, if you wish to select an equal sign (=) as a Label ID, the chart indicates its associated hex characters as 3D.
5. Turn to [Appendix C](#) and scan the bar codes representing the hex characters determined in the previous step. For example, to make an equal sign (=), scan '3' and 'D' followed by '0' six times. Since this is a three-character buffer, '00' is scanned for character two, '00' for character three and '00' for the control character. ('00' indicates no character.)
6. Scan the END bar code to exit programming mode.

**Figure 11. Label ID Position Options**

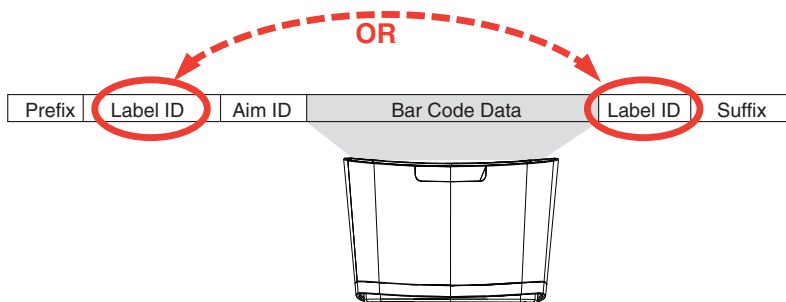

## LENGTH CONTROL

**Fixed Length Decoding:** When fixed length decoding is enabled, the scanner will decode a bar code if the label length matches one of the configurable fixed lengths.

**Variable Length Decoding:** When variable length decoding is enabled, the scanner will decode a bar code if the label length falls in the range of the configurable minimum and maximum length.

Configuring Fixed Length Decoding:

1. Scan the Enter/Exit Programming Mode bar code.
2. Scan the Fixed Length Decoding bar code for the desired symbology.
3. Scan the Enter/Exit Programming Mode bar code.
4. Set Length 1 to the first fixed length by following the [Length 1, Length 2 Programming Instructions](#) below.
5. Set Length 2 to the second fixed length (or to '00' if there is only one fixed length) by following the [Length 1, Length 2 Programming Instructions](#) below.

### Configuring Variable Length Decoding:

1. Scan the Enter/Exit Programming Mode bar code.
2. Scan the Variable Length Decoding bar code for the desired symbology.
3. Scan the Enter/Exit Programming Mode bar code.
4. Set Length 1 to the first variable length by following the [Length 1, Length 2 Programming Instructions](#) below.
5. Set Length 2 to the second variable length by following the [Length 1, Length 2 Programming Instructions](#) below.

### Length 1, Length 2 Programming Instructions

1. Scan the Enter/Exit Programming Mode bar code.
2. Scan either the Set Length 1 or Set Length 2 bar code for the desired symbology.
3. Turn to [Appendix C](#) and scan the two digits (zero padded) representing the length in decimal notation. The number of characters that can be set varies, depending upon the symbology. Reference the page for your selected symbology to see specific variables.
4. Scan the Enter/Exit Programming Mode bar code.

# APPENDIX A

## PRODUCT SPECIFICATIONS

---

SECTION CONTENTS
<b>TECHNICAL SPECIFICATIONS</b> starting on page 266 <ul style="list-style-type: none"><li>• <b>DECODING CAPABILITY</b> starting on page 266</li><li>• <b>ELECTRICAL SPECIFICATIONS</b> starting on page 255</li><li>• <b>ENVIRONMENTAL</b> starting on page 255</li><li>• <b>INTERFACES</b> starting on page 255</li><li>• <b>OPTIONAL FEATURES</b> starting on page 267</li><li>• <b>OPTIONAL FEATURES</b> starting on page 267</li></ul>
<b>PHYSICAL CHARACTERISTICS</b> starting on page 268
<b>READING PERFORMANCE</b> starting on page 269 <ul style="list-style-type: none"><li>• <b>READING RANGES</b> starting on page 269</li></ul>
<b>SAFETY &amp; REGULATORY</b> starting on page 269
<b>WARRANTY</b> starting on page 258
<b>WARRANTY</b> starting on page 270
<b>LED AND BEEPER INDICATORS</b> starting on page 258
<b>ERROR CODES</b> starting on page 259



## TECHNICAL SPECIFICATIONS

### Decoding Capability

ITEM	DESCRIPTION
1D / Linear Codes	Autodiscriminates All Standard 1D Codes Including GS1 Databar™ Linear Codes.
2D Codes	Aztec Code; Data Matrix (ECC200 Only); QR Code
Stacked Codes	GS1 Databar Composites; GS1 Databar Expanded Stacked; GS1 Databar Stacked; GS1 Databar Stacked Omnidirectional; Micro-PDF417; PDF417
Digital Watermarks	Optional Support For Digimarc® Barcodes/GS1 DW Code

### Electrical Specifications

ITEM	DESCRIPTION
AC Power Requirements	AC Input: 100-240 Vac, 50-60 Hz; DC Input: 5-12 V
Power Consumption	Operating (Maximum): 4.0 Watts; Operating (Nominal): 3.75 Watts Sleep Mode: 3.0 Watts

### Environmental

ITEM	DESCRIPTION
Ambient Light	0 - 86,100 Lux
ESD Protection (Air Discharge)	25 kV
Humidity (Non-condensing)	5 - 95%
Particulate And Water Sealing	IP52
Temperature	Operating: 10 to 40 °C / 50 to 104 °F Storage/transport: -40 to 70 °C / -40 to 158 °F

### Interfaces

PARAMETER	SPECIFICATION
Interfaces	OEM (IBM) USB; RS-232; USB Keyboard; USB COM Powered Type A USB (USB Com)

### Optional Features

PARAMETER	SPECIFICATION
EAS Features	Good Read signal available for use with various EAS hardware, such as Checkpoint Systems and Sensormatic devices.
Value Added Features	Diagnostic Reporting; Host Download; Magellan ULE Scripting

# PHYSICAL CHARACTERISTICS

PARAMETER	SPECIFICATION
Dimensions	Magellan Model 3450VSi: 13.7 X 15.2 X 9.4 cm / 5.4 X 6.0 X 3.7 in
Weight	0.6 kg /1.3 lb

## Scanner Dimensions

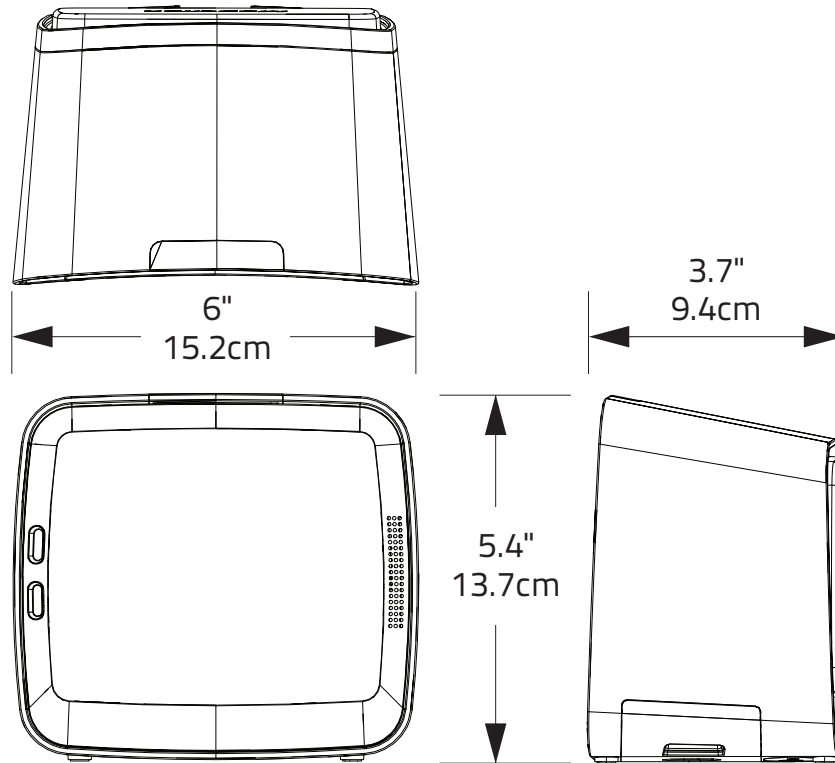

## READING PERFORMANCE

PARAMETER	SPECIFICATION
Image Capture	Graphic Formats: BMP, JPEG
Imager Sensor	1280 X 1024
Light Source	Multiple Diffused LEDs, Orientation and Wavelength Optimized for Eye Comfort
Print Contrast Ratio (Minimum)	25%
Read Height	14.0 cm / 5.5 in
Read Rate (Maximum)	39 Million Pixels per Second
Reading Angle	Pitch: +/- 65°; Roll (Tilt): 0 - 360°; Skew (Yaw): +/- 75°
Reading Indicators	Audio Speaker w/Adjustable Tone and Volume, Supports .wav Files; Good Read LED; Good Transmission
Resolution (Maximum)	5 Mil

## Reading Ranges

PARAMETER	SPECIFICATION
Typical Depth Of Field	Printing Resolution, Symbol Length, Scan Angle, Contrast and Ambient Light Dependent
1D / Linear Codes	5 Mils: 3.8 to 8.1 cm / 1.5 to 3.2 in
	7.5 Mils: 1.3 to 11.4 cm / 0.5 to 4.5 in
	10 Mils: 0 to 15.2 cm / 0 to 6.0 in
	13 Mils: 0 to 20.3 cm / 0 to 8.0 in
2D Codes (Optional)	6.6 Mils: PDF: 3.8 to 10.2 cm / 1.5 to 4.0 in
	10 Mils: PDF: 0 to 12.7 cm / 0 to 5.0 in
	10 Mils: Data Matrix: 1.3 to 6.4 cm / 0.5 to 2.5 in

## SAFETY & REGULATORY

PARAMETER	SPECIFICATION
Agency Approvals	The product meets necessary safety and regulatory approvals for its intended use.
Environmental Compliance	Complies to China RoHS; Complies to EU RoHS
LED Classification	EN62471 and IEC62471 Lamp Illumination - Exempt Group

## UTILITIES

PARAMETER	SPECIFICATION
Scanalyzer	Magellan Scanalyzer Configuration Software is available for download at no charge.
OPOS / JavaPOS	JavaPOS Utilities are available for download at no charge. OPOS Utilities are available for download at no charge.

## WARRANTY

Warranty	3-year Factory Warranty
----------	-------------------------

## LED AND BEEPER INDICATORS

The scanner's beeper sounds and its green LED illuminates to indicate various functions or errors on the scanner. The tables below list these indications. The scanner's functions are programmable, and so may or may not be turned on. For example, certain indications such as the power-up beep can be disabled using programming bar code labels.

LED INDICATION	INDICATION	COMMENT
Power-on indication	Bright green flash	Indicates the scanner has finished all its power up tests and is now ready for operation.
Good Read Indication	Bright green flash	Indicates a bar code has been read and decoded.
Scanner Ready	Constant dim green	The scanner is ready for operation. The LED is also configurable to off when idle and ready for operation
Sleep Mode	Green LED slowly and continuously changes from off to dim to off.	The scanner is in Sleep Mode. To wake the scanner up, move an object in front of its window or press the button atop the unit. This indication is configurable and may be programmed to behave differently.
Host Disable	Constant green flash at 1 Hz (100mS on, 900mS off)	The scanner is disabled due to receiving a disable command from the POS terminal.
Diagnostics	Varies (see Error Codes on page 259 for more information)	The LED can provide diagnostic feedback if the scanner discovers a problem during SelfTest.
Prog. Mode	See Host Disable above.	The scanner is in Programming Mode.

BEEPER INDICATION	INDICATION	COMMENT
Power On Beep	Single beep	The Power-On Beep indication is a configurable feature which can be enabled or disabled. When enabled, this beep indicates the scanner has finished all its power up tests and is now ready for operation.
Good Read Indication	Single beep	The good read beep indication is configurable. Options include: Enable/disable, frequency, duration and volume. See <a href="#">LED and Beeper Indicators</a> on page 2-57 for more information.
Diagnostics	Varies (see <a href="#">"Error Codes"</a> for more information)	The Beeper can provide diagnostic feedback if the scanner discovers a problem during SelfTest.
Programming Mode Indications	Varies depending upon the feature(s) being configured.	The Beeper will sound as programming bar code labels are scanned, indicating progress during scanner configuration.

## ERROR CODES

If an error is detected, the scanner will sound a long low tone (for three seconds) and flash its LED, indicating a failure. When this occurs, press the Scanner Pushbutton to hear the error code. If it is configured to do so, the scanner will sound a series of beeps corresponding to the error code and/or flash its LED simultaneous to the beeps. The table below describes what these codes mean and what action should be taken for each.

NUMBER OF LED FLASHES/ BEEPS	ERROR	CORRECTIVE ACTION
1	Configuration	Contact Helpdesk for assistance
2	Interface PCB	
6	Main PCB	
10	Button Error	
12	Imager Module	
13	Software ID Failure	
14	Software Fatal Fault	

# APPENDIX B

## CABLE PINOUTS

---

### STANDARD CABLE PINOUTS (PRIMARY INTERFACE CABLES)

Pin #	RS-232	USB-OEM	USB, USB Keyboard, USB COM
1		D+	D+
2	CTS		
3		D-	D-
4	RTS		
5	RxD		
6	TxD		
7			
8	Vin	Vin/VBUS	Vin/VBUS
9	GND	GND	GND
10	ERI	ERI	ERI

# APPENDIX C

## ALPHA-NUMERIC KEYPAD

---





1



2

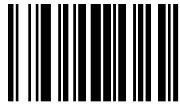

3



4

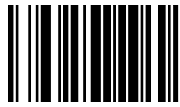

5



6



7



8



9



0



# APPENDIX D

## FACTORY DEFAULT SETTINGS

The following table provides a listing of the most common factory settings for the interfaces shown.



**NOTE: Some of the individual interfaces listed in the defaults table below appear in the same column since they share similar feature settings with few (if any) exceptions.**

**Keep in mind though, that the actual configuration storage area for each interface is unique and that updates & changes to factory defaults can be made at any time without notice.**

### Factory Default Settings

Feature	Default Master	RS-232	RS-232 Wincor-Nixdorf	Keyboard	USB COM / USB TEC	USB OEM
<b>General Scanner Features</b>						
1D Double Read Timeout	28 (400ms)	28 (400ms)	28 (400ms)	28 (400ms)	28 (400ms)	28 (400ms)
2D Double Read Timeout	46 (700ms)	46 (700ms)	46 (700ms)	46 (700ms)	46 (700ms)	46 (700ms)
Digital Watermark (Digimarc) Enable	01 (enable)	01 (enable)	01 (enable)	01 (enable)	01 (enable)	01 (enable)
Digital Watermark (Digimarc) Double Read Timeout	0.5 Sec.	0.5 Sec.	0.5 Sec.	0.5 Sec.	0.5 Sec.	0.5 Sec.
Digital Watermark (Digimarc) Data Format	00 (compatibility mode)	00 (compatibility mode)	00 (compatibility mode)	00 (compatibility mode)	00 (compatibility mode)	00 (compatibility mode)
Sleep Mode Timer	5 minutes	5 minutes	5 minutes	5 minutes	5 minutes	5 minutes
1D Inverse Read Control	0000 (disable)	0000 (disable)	0000 (disable)	0000 (disable)	0000 (disable)	0000 (disable)
2D Inverse Read Control	00 (disable)	00 (disable)	00 (disable)	00 (disable)	00 (disable)	00 (disable)
Power On Alert	01 (enable)	01 (enable)	01 (enable)	01 (enable)	01 (enable)	01 (enable)
Object Sense Control	40 (enable)	40 (enable)	40 (enable)	40 (enable)	40 (enable)	40 (enable)
Reading Illumination Duration	64 (5 sec)	64 (5 sec)	64 (5 sec)	64 (5 sec)	64 (5 sec)	64 (5 sec)
Good Read LED Idle State	02 (on dim)	02 (on dim)	02 (on dim)	02 (on dim)	02 (on dim)	02 (on dim)
Scanner Control Button Options	01	01	01	01	01	01

Feature	Default Master	RS-232	RS-232 Wincor-Nixdorf	Keyboard	USB COM / USB TEC	USB OEM
Good Read Beep Control	01 (enable)	01 (enable)	01 (enable)	01 (enable)	01 (enable)	01 (enable)
Good Read Beep Frequency	01 (med.)	01 (med.)	01 (med.)	01 (med.)	01 (med.)	01 (med.)
Good Read Beep Length	008 (80ms)	008 (80ms)	008 (80ms)	008 (80ms)	008 (80ms)	008 (80ms)
Good Read Beep Volume	02 (med)	02 (med)	02 (med)	02 (med)	02 (med)	02 (med)
Good Read When to Indicate	00 (after decode)	00 (after decode)	00 (after decode)	00 (after decode)	00 (after decode)	00 (after decode)
Handheld Host Download Timeout	0F (15 seconds)	0F (15 seconds)	0F (15 seconds)	0F (15 seconds)	0F (15 seconds)	0F (15 seconds)
<b>Imaging Features</b>						
Camera Button Mode	00 (disable)	00 (disable)	00 (disable)	00 (disable)	00 (disable)	00 (disable)
Image Destination	00 (disable)	00 (disable)	00 (disable)	00 (disable)	00 (disable)	00 (disable)
Cell Phone Mode	02 (Enable)	02 (Enable)	02 (Enable)	02 (Enable)	02 (Enable)	02 (Enable)
Cell Mode Percent	00 (Very Low)	00 (Very Low)	00 (Very Low)	00 (Very Low)	00 (Very Low)	00 (Very Low)
Picture Retrieval Timeout	05 (5 sec.)	05 (5 sec.)	05 (5 sec.)		05 (5 sec.)	05 (5 sec.)
Image Capture Delay	05 (5 sec.)	05 (5 sec.)	05 (5 sec.)	05 (5 sec.)	05 (5 sec.)	05 (5 sec.)
Image Format	00 (JPG)	00 (JPG)	00 (JPG)	00 (JPG)	00 (JPG)	00 (JPG)
Image Size	00 (VGA)	00 (VGA)	00 (VGA)	00 (VGA)	00 (VGA)	00 (VGA)
Image Brightness	Level 0	Level 0	Level 0	Level 0	Level 0	Level 0
Image Contrast	Level 0	Level 0	Level 0	Level 0	Level 0	Level 0
Image Compression	64 (Compression = 100)	64 (Compression = 100)	64 (Compression = 100)	64 (Compression = 100)	64 (Compression = 100)	64 (Compression = 100)
Region of Interest (ROI)	000004FF00003FF (full size)	000004FF00003FF (full size)	000004FF00003FF (full size)	000004FF00003FF (full size)	000004FF00003FF (full size)	000004FF00003FF (full size)
<b>Interface Related Features</b>						
Maximum Host-Transmitted Message Length	000 (no gen. limit imposed)	000 (no gen. limit imposed)	000 (no gen. limit imposed)	000 (no gen. limit imposed)	000 (no gen. limit imposed)	000 (no gen. limit imposed)
RS-232 Baud Rate	01 (9600)	01 (9600)	01 (9600)		01 (9600)	
RS-232 Number of Data Bits	01 (8 data bits)	01 (8 data bits)	01 (8 data bits)		01 (8 data bits)	
RS-232 Number of Stop Bits	00 (1 stop bit)	00 (1 stop bit)	00 (1 stop bit)		00 (1 stop bit)	
RS-232 Parity	00 (none)	00 (none)	02 (odd)		00 (none)	
RS-232 Hardware Control	00 (disable)	00 (disable)	01 (enable CTS flow control)		00 (disable)	
RS-232 Intercharacter Delay	00 (no delay)	00 (no delay)	00 (no delay)		00 (no delay)	
RS-232 Software Flow Control	00 (disable)	00 (disable)	00 (disable)		00 (disable)	

Feature	Default Master	RS-232	RS-232 Wincor-Nixdorf	Keyboard	USB COM / USB TEC	USB OEM
RS-232 Beep on ASCII BEL	00 (disable)	00 (disable)	00 (disable)		00 (disable)	
Beep on Not on File	01 (low vol)	01 (low vol)	01 (low vol)		01 (low vol)	01 (low vol)
ACK NAK Enable	00 (disable)	00 (disable)	00 (disable)		00 (disable)	
RS-232 ACK Character	06 (ACK)	06 (ACK)	06 (ACK)		06 (ACK)	
RS-232 NAK Character	15 (NAK)	15 (NAK)	15 (NAK)		15 (NAK)	
RS-232 Retry on ACK NAK Timeout	01 (enable)	01 (enable)	01 (enable)		01 (enable)	
RS-232 ACK NAK Timeout Value	01 (200ms)	01 (200ms)	01 (200ms)		01 (200ms)	
RS-232 ACK NAK Retry Count	03 (3 retries)	03 (3 retries)	03 (3 retries)		03 (3 retries)	
RS-232 ACK NAK Error Handling	00 (ignore)	00 (ignore)	00 (ignore)		00 (ignore)	
RS-232 Indicate Transmission Failure	01 (enable)	01 (enable)	01 (enable)		01 (enable)	
RS-232 Ignore Host Commands	00	00	00	00	00	00
USB-OEM Interface Features	02	02	02	02	02	01
USB OEM Scanner Device Type	00 (table top)					00 (table top)
USB OEM Additional Interface Options	00 (disabled upon enumeration)					00 (disabled upon enumeration)
USB Keyboard Country Mode	00 (USA)			00 (USA)		
USB Keyboard Caps Lock State	00 (caps lock OFF)			00 (caps lock OFF)		
No Keyboard Support	00 (disable)			00 (disable)		
USB Keyboard Send Control Characters	00 (disable)			00 (disable)		
Quiet Interval	0A (100ms)			0A (100ms)		
USB Keyboard Inter-character Delay	01 (10ms)			01 (10ms)		
USB Keyboard Additional Interface Options	40 (Rev D)	00	00	40 (Rev D)	40 (Rev D)/00	46

Feature	Default Master	RS-232	RS-232 Wincor-Nixdorf	Keyboard	USB COM / USB TEC	USB OEM
<b>Data Editing</b>						
Global Prefix	00 (no prefix)	00 (no prefix)	00 (no prefix)	00 (no prefix)	00 (no prefix)	00 (no prefix)
Global Suffix	0D00 (CR)	0D00 (CR)	0D00 (CR)	0D00 (CR)	0D00 (CR)	0D00 (CR)
AIM ID	00 (disable)	00 (disable)	00 (disable)	00 (disable)	00 (disable)	
Label ID	01 (Enable as prefix)	01 (Enable as prefix)	01 (Enable as prefix)	01 (Enable as prefix)	01 (Enable as prefix)	
Global Mid-Label ID	00 (no mid-label ID)	00 (no mid-label ID)	00 (no mid-label ID)	00 (no mid-label ID)	00 (no mid-label ID)	
Case Conversion	00 (no case convers'n)	00 (no case convers'n)	00 (no case convers'n)	00 (no case convers'n)	00 (no case convers'n)	00 (no case convers'n)
Character Conversion	FFFFFFFF FFFFFFFF (no char. convers'n)	FFFFFFFF FFFFFFFF (no char. convers'n)	FFFFFFFF FFFFFFFF (no char. convers'n)	FFFFFFFF FFFFFFFF (no char. convers'n)	FFFFFFFF FFFFFFFF (no char. convers'n)	FFFFFFFF FFFFFFFF (no char. convers'n)
<b>1D Symbology Programming</b>						
Coupon Control Enable	01 (enable UPC-A)	03 (UPC-A coupon priority)	03 (UPC-A coupon priority)	03 (UPC-A coupon priority)	03 (UPC-A coupon priority)	03 (UPC-A coupon priority)
Coupon Label Priority Timer	0.2 Sec.	0.2 Sec.	0.2 Sec.	0.2 Sec.	0.2 Sec.	0.2 Sec.
UPC-A Enable	01 (enable)	01 (enable)	01 (enable)	01 (enable)	01 (enable)	01 (enable)
UPC-A Number System Character Transmission	01 (enable)	01 (enable)	01 (enable)	01 (enable)	01 (enable)	01 (enable)
UPC-A Check Character Transmission	01 (enable)	01 (enable)	01 (enable)	01 (enable)	01 (enable)	01 (enable)
UPC-A Minimum Read	01 (1 read)	01 (1 read)	01 (1 read)	01 (1 read)	01 (1 read)	01 (1 read)
Expand UPC-A to EAN-13	00 (disable)	00 (disable)	01 (enable)	00 (disable)	00 (disable)	00 (disable)
UPC-E Enable	01 (enable)	01 (enable)	01 (enable)	01 (enable)	01 (enable)	01 (enable)
UPC-E Number System Character Transmission	01 (enable)	01 (enable)	01 (enable)	01 (enable)	01 (enable)	01 (enable)
UPC-E Check Character Transmission	01 (enable)	01 (enable)	00 (disable)	01 (enable)	01 (enable)	01 (enable)
Expand UPC-E to UPC-A	00 (disable)	00 (disable)	00 (disable)	00 (disable)	00 (disable)	00 (disable)
Expand UPC-E to EAN-13	00 (disable)	00 (disable)	00 (disable)	00 (disable)	00 (disable)	00 (disable)
UPC-E Minimum Read	01 (1 read)	01 (1 read)	01 (1 read)	01 (1 read)	01 (1 read)	01 (1 read)
EAN-13	01 (enable)	01 (enable)	01 (enable)	01 (enable)	01 (enable)	01 (enable)
EAN-13 First Character Transmission	01 (enable)	01 (enable)	01 (enable)	01 (enable)	01 (enable)	01 (enable)
EAN-13 Check Character Transmission	01 (enable)	01 (enable)	01 (enable)	01 (enable)	01 (enable)	01 (enable)
EAN-13 ISBN Conversion Enable	00 (disable)	00 (disable)	00 (disable)	00 (disable)	00 (disable)	00 (disable)
EAN-13 Minimum Read	01 (1 read)	01 (1 read)	01 (1 read)	01 (1 read)	01 (1 read)	01 (1 read)

Feature	Default Master	RS-232	RS-232 Wincor-Nixdorf	Keyboard	USB COM / USB TEC	USB OEM
EAN-8	01 (enable)	01 (enable)	01 (enable)	01 (enable)	01 (enable)	01 (enable)
EAN-8 Check Character Transmission	01 (enable)	01 (enable)	01 (enable)	01 (enable)	01 (enable)	01 (enable)
Expand EAN-8 to EAN-13	00 (disable)	00 (disable)	00 (disable)	00 (disable)	00 (disable)	00 (disable)
EAN-8 Minimum Read	01 (1 read)	01 (1 read)	01 (1 read)	01 (1 read)	01 (1 read)	01 (1 read)
EAN-8 Guard Insertion	00 (disable)	00 (disable)	00 (disable)	00 (disable)	00 (disable)	00 (disable)
EAN-8 Guard Substitution	00 (disable)	00 (disable)	00 (disable)	00 (disable)	00 (disable)	00 (disable)
EAN-8/Jan-8 Both Guards Substitution	00 (disable)	00 (disable)	00 (disable)	00 (disable)	00 (disable)	00 (disable)
EAN-8 Stitch Exact Label Halves	00 (disable)	00 (disable)	00 (disable)	00 (disable)	00 (disable)	00 (disable)
EAN-8 Stitch Unlike Label Halves	00 (disable)	00 (disable)	00 (disable)	00 (disable)	00 (disable)	00 (disable)
EAN-8 Minimum Segment Length	08	08	08	08	08	08
EAN-8 Decoding Levels	01 (very conservative)	01 (very conservative)	01 (very conservative)	01 (very conservative)	01 (very conservative)	01 (very conservative)
In-Store Printed Label Minimum Read	01 (1 read)	01 (1 read)	01 (1 read)	01 (1 read)	01 (1 read)	01 (1 read)
UPC/EAN Correlation	00 (disable)	00 (disable)	00 (disable)	00 (disable)	00 (disable)	00 (disable)
UPC/EAN Guard Insertion	00 (disable)	00 (disable)	00 (disable)	00 (disable)	00 (disable)	00 (disable)
UPC/EAN Stitch Exact Label Halves	00 (disable)	00 (disable)	00 (disable)	00 (disable)	00 (disable)	00 (disable)
UPC/EAN Stitch Unlike Label Halves	00 (disable)	00 (disable)	00 (disable)	00 (disable)	00 (disable)	00 (disable)
UPC/EAN Minimum Segment Length	05 (5 char.)	05 (5 char.)	05 (5 char.)	05 (5 char.)	05 (5 char.)	05 (5 char.)
Price Weight Check	00 (disable)	00 (disable)	00 (disable)	00 (disable)	00 (disable)	00 (disable)
Enable EAN Two Label	00 (disable)	00 (disable)	00 (disable)	00 (disable)	00 (disable)	00 (disable)
EAN Two Label Minimum Read	01 (1 read)	01 (1 read)	01 (1 read)	01 (1 read)	01 (1 read)	01 (1 read)
EAN Two Label Combined Transmission	00 (disable)	00 (disable)	00 (disable)	00 (disable)		
Add-ons	disable all	disable all	disable all	disable all	disable all	disable all
P2 Add-on Minimum Read	02 (2 reads)	02 (2 reads)	02 (2 reads)	02 (2 reads)	02 (2 reads)	02 (2 reads)
P5 Add-on Minimum Read	01 (1 read)	01 (1 read)	01 (1 read)	01 (1 read)	01 (1 read)	01 (1 read)
UPC/EAN Composites	00 (disable)	00 (disable)	00 (disable)	00 (disable)	00 (disable)	
GTIN	00 (disable)	00 (disable)	00 (disable)	00 (disable)	00 (disable)	
DataBar Omnidirectional Enable	00 (disable)	00 (disable)	00 (disable)	00 (disable)	00 (disable)	00 (disable)
DataBar Omnidirectional/EAN-128 Emulation	00 (disable)	00 (disable)	00 (disable)	00 (disable)	00 (disable)	00 (disable)

Feature	Default Master	RS-232	RS-232 Wincor-Nixdorf	Keyboard	USB COM / USB TEC	USB OEM
DataBar Omnidirectional 2D Component Enable	00 (disable)	00 (disable)	00 (disable)	00 (disable)	00 (disable)	00 (disable)
DataBar Omnidirectional Minimum Read	01 (1 read)	01 (1 read)	01 (1 read)	01 (1 read)	01 (1 read)	01 (1 read)
DataBar Omnidirectional Double Read Timeout	2.5 Sec.	2.5 Sec.	2.5 Sec.	2.5 Sec.	2.5 Sec.	2.5 Sec.
DataBar Limited Enable	00 (disable)	00 (disable)	00 (disable)	00 (disable)	00 (disable)	00 (disable)
DataBar Limited Minimum Read	01 (1 read)	01 (1 read)	01 (1 read)	01 (1 read)	01 (1 read)	01 (1 read)
DataBar Limited 2D Component Enable	00 (disable)	00 (disable)	00 (disable)	00 (disable)	00 (disable)	00 (disable)
DataBar Limited EAN128 Emulation Enable	00 (disable)	00 (disable)	00 (disable)	00 (disable)	00 (disable)	00 (disable)
DataBar Expanded	00 (disable)	00 (disable)	00 (disable)	00 (disable)	00 (disable)	00 (disable)
DataBar Expanded EAN-128 Emulation	00 (disable)	00 (disable)	00 (disable)	00 (disable)	00 (disable)	00 (disable)
DataBar Expanded 2D Component Enable	00 (disable)	00 (disable)	00 (disable)	00 (disable)	00 (disable)	00 (disable)
DataBar Expanded Minimum Read	01 (1 read)	01 (1 read)	01 (1 read)	01 (1 read)	01 (1 read)	01 (1 read)
DataBar Expanded Length Control	00 (variable)	00 (variable)	00 (variable)	00 (variable)	00 (variable)	00 (variable)
DataBar Expanded Length 1	01	01	01	01	01	01
DataBar Expanded Length 2	4A	4A	4A	4A	4A	4A
DataBar Expanded Reverse Retry	00 (disable)	00 (disable)	00 (disable)	00 (disable)	00 (disable)	00 (disable)
Code 39	01 (enable)	01 (enable)	01 (enable)	01 (enable)	01 (enable)	01 (enable)
Code 39 Start Stop Character Transmission	00 (disable)	00 (disable)	00 (disable)	00 (disable)	00 (disable)	00 (disable)
Code 39 Check Character Calculation	00 (disable)	00 (disable)	00 (disable)	00 (disable)	00 (disable)	00 (disable)
Code 39 Check Character Transmission	01 (enable)	01 (enable)	01 (enable)	01 (enable)	01 (enable)	01 (enable)
Code 39 Full ASCII	00 (disable)	00 (disable)	00 (disable)	00 (disable)	00 (disable)	00 (disable)
Code 39 Minimum Read	01 (1 read)	01 (1 read)	01 (1 read)	01 (1 read)	01 (1 read)	01 (1 read)
Code 39 Correlation	00 (disable)	00 (disable)	00 (disable)	00 (disable)	00 (disable)	00 (disable)
Code 39 Length Control	00 (variable)	00 (variable)	00 (variable)	00 (variable)	00 (variable)	00 (variable)
Code 39 Length 1	02	02	02	02	02	02
Code 39 Length 2	32	32	32	32	32	32
Code 39 Stitching	01 (enable)	01 (enable)	01 (enable)	01 (enable)	01 (enable)	01 (enable)
Code 39 Require Margins	00 (disable)	00 (disable)	00 (disable)	00 (disable)	00 (disable)	00 (disable)

Feature	Default Master	RS-232	RS-232 Wincor-Nixdorf	Keyboard	USB COM / USB TEC	USB OEM
Code 32 Italian Pharmacode	00 (disable)	00 (disable)	00 (disable)	00 (disable)	00 (disable)	00 (disable)
Code 32 Start Stop Character Transmission	00 (disable)	00 (disable)	00 (disable)	00 (disable)	00 (disable)	00 (disable)
Code 32 Check Character Transmission	00 (disable)	00 (disable)	00 (disable)	00 (disable)	00 (disable)	
Code 128	01 (enable)	01 (enable)	01 (enable)	01 (enable)	01 (enable)	01 (enable)
Code 128 Transmit Function Characters	00 (disable)	00 (disable)	00 (disable)	00 (disable)	00 (disable)	00 (disable)
Expand Code 128 to Code 39	00 (disable)	00 (disable)	00 (disable)	00 (disable)	00 (disable)	00 (disable)
Code 128 Minimum Read	01 (1 read)	01 (1 read)	01 (1 read)	01 (1 read)	01 (1 read)	01 (1 read)
Code 128 Correlation	00 (disable)	00 (disable)	00 (disable)	00 (disable)	00 (disable)	00 (disable)
Code 128 Length Control	00 (variable)	00 (variable)	00 (variable)	00 (variable)	00 (variable)	00 (variable)
Code 128 Length 1	01	01	01	01	01	01
Code 128 Length 2	50	50	50	50	50	50
Code 128 Stitching	01 (enable)	01 (enable)	01 (enable)	01 (enable)	01 (enable)	01 (enable)
EAN-128	00 (disable)	00 (disable)	00 (disable)	00 (disable)	00 (disable)	00 (disable)
Interleaved 2 of 5 (I 2 OF 5)	00 (disable)	00 (disable)	00 (disable)	00 (disable)	00 (disable)	00 (disable)
I 2 of 5 Check Character Calculation	00 (disable)	00 (disable)	00 (disable)	00 (disable)	00 (disable)	00 (disable)
I 2 of 5 Check Character Transmission	01 (enable)	01 (enable)	01 (enable)	01 (enable)	01 (enable)	01 (enable)
I 2 of 5 Minimum Read	01 (1 read)	01 (1 read)	01 (1 read)	01 (1 read)	01 (1 read)	01 (1 read)
I 2 of 5 Correlation	00 (disable)	00 (disable)	00 (disable)	00 (disable)	00 (disable)	00 (disable)
I 2 of 5 Length Control	00 (variable)	00 (variable)	00 (variable)	00 (variable)	00 (variable)	00 (variable)
I 2 of 5 Length 1	06	06	06	06	06	06
I 2 of 5 Length 2	32	32	32	32	32	32
I 2 of 5 Stitching	00 (disable)	00 (disable)	00 (disable)	00 (disable)	00 (disable)	00 (disable)
Codabar	00 (disable)	00 (disable)	00 (disable)	00 (disable)	00 (disable)	00 (disable)
Codabar Start Stop Character Transmission	01 (enable)	01 (enable)	01 (enable)	01 (enable)	01 (enable)	01 (enable)
Codabar Start Stop Character Set	03 (abcd/abcd)	03 (abcd/abcd)	03 (abcd/abcd)	03 (abcd/abcd)	03 (abcd/abcd)	03 (abcd/abcd)
Codabar Start Stop Character Match	00 (disable)	00 (disable)	00 (disable)	00 (disable)	00 (disable)	00 (disable)
Codabar Check Character Calculation	00 (disable)	00 (disable)	00 (disable)	00 (disable)	00 (disable)	00 (disable)
Codabar Check Character Transmission	01 (enable)	01 (enable)	01 (enable)	01 (enable)	01 (enable)	01 (enable)
Codabar Minimum Read	01 (1 read)	01 (1 read)	01 (1 read)	01 (1 read)	01 (1 read)	01 (1 read)
Codabar Correlation	00 (disable)	00 (disable)	00 (disable)	00 (disable)	00 (disable)	00 (disable)

Feature	Default Master	RS-232	RS-232 Wincor-Nixdorf	Keyboard	USB COM / USB TEC	USB OEM
Codabar Length Control	00 (variable)	00 (variable)	00 (variable)	00 (variable)	00 (variable)	00 (variable)
Codabar Length 1	03	03	03	03	03	03
Codabar Length 2	32	32	32	32	32	32
Codabar Stitching	00 (disable)	00 (disable)	00 (disable)	00 (disable)	00 (disable)	00 (disable)
Codabar Require Margins	00 (disable)	00 (disable)	00 (disable)	00 (disable)	00 (disable)	00 (disable)
Code 93	00 (disable)	00 (disable)	00 (disable)	00 (disable)	00 (disable)	00 (disable)
Code 93 Minimum Read	01 (1 read)	01 (1 read)	01 (1 read)	01 (1 read)	01 (1 read)	01 (1 read)
Code 93 Correlation	00 (disable)	00 (disable)	00 (disable)	00 (disable)	00 (disable)	00 (disable)
Code 93 Length Control	00 (variable)	00 (variable)	00 (variable)	00 (variable)	00 (variable)	00 (variable)
Code 93 Length 1	01	01	01	01	01	01
Code 93 Length 2	32	32	32	32	32	32
Code 93 Stitching	01 (enable)	01 (enable)	01 (enable)	01 (enable)	01 (enable)	01 (enable)
MSI	00 (disable)	00 (disable)	00 (disable)	00 (disable)	00 (disable)	
MSI Check Character Calculation	01 (enable)	01 (enable)	01 (enable)	01 (enable)	01 (enable)	
MSI Number of Check Characters	00 (1 char)	00 (1 char)	00 (1 char)	00 (1 char)	00 (1 char)	
MSI Check Character Transmission	01 (enable)	01 (enable)	01 (enable)	01 (enable)	01 (enable)	
MSI Minimum Read	01 (1 read)	01 (1 read)	01 (1 read)	01 (1 read)	01 (1 read)	
MSI Correlation	00 (disable)	00 (disable)	00 (disable)	00 (disable)	00 (disable)	
MSI Length Control	00 (variable)	00 (variable)	00 (variable)	00 (variable)	00 (variable)	
MSI Length 1	04	04	04	04	04	
MSI Length 2	10	10	10	10	10	
MSI Stitching	00 (disable)	00 (disable)	00 (disable)	00 (disable)	00 (disable)	
Standard 2 of 5	00 (disable)	00 (disable)	00 (disable)	00 (disable)	00 (disable)	00 (disable)
Standard 2 of 5 Check Character Calculation	00 (disable)	00 (disable)	00 (disable)	00 (disable)	00 (disable)	00 (disable)
Standard 2 of 5 Check Character Transmission	01 (enable)	01 (enable)	01 (enable)	01 (enable)	01 (enable)	01 (enable)
Standard 2 of 5 Minimum Read	01 (1 read)	01 (1 read)	01 (1 read)	01 (1 read)	01 (1 read)	01 (1 read)
Standard 2 of 5 Correlation	00 (disable)	00 (disable)	00 (disable)	00 (disable)	00 (disable)	00 (disable)
Standard 2 of 5 Length Control	00 (variable)	00 (variable)	00 (variable)	00 (variable)	00 (variable)	00 (variable)
Standard 2 of 5 Length 1	08	08	08	08	08	08
Standard 2 of 5 Length 2	32	32	32	32	32	32
Standard 2 of 5 Stitching	00 (disable)	00 (disable)	00 (disable)	00 (disable)	00 (disable)	00 (disable)



Feature	Default Master	RS-232	RS-232 Wincor-Nixdorf	Keyboard	USB COM / USB TEC	USB OEM
<b>2D Symbology Programming</b>						
Data Matrix	00 (disable)	00 (disable)	00 (disable)	00 (disable)	00 (disable)	00 (disable)
Data Matrix Length Control	00 (variable)	00 (variable)	00 (variable)	00 (variable)	00 (variable)	00 (variable)
Set Data Matrix Length 1	0001	0001	0001	0001	0001	0001
Set Data Matrix Length 2	0320	0320	0320	0320	0320	0320
GS1 Datamatrix Enable	00 (transmit as std Data-matrix label)	00 (transmit as std Data-matrix label)	01 (transmit as GS1 Data-matrix label)	00 (transmit as std Data-matrix label)	00 (transmit as std Data-matrix label)	00 (transmit as std Data-matrix label)
PDF 417 Enable	00 (disable)	00 (disable)	00 (disable)	00 (disable)	00 (disable)	00 (disable)
PDF 417 Length Control	00 (variable)	00 (variable)	00 (variable)	00 (variable)	00 (variable)	00 (variable)
Set PDF 417 Length 1	0001	0001	0001	0001	0001	0001
Set PDF 417 Length 2	0A96	0A96	0A96	0A96	0A96	0A96
PDF 417 Read Option	00 (none)	00 (none)	00 (none)	00 (none)	00 (none)	00 (none)
Micro PDF 417	00 (disable)	00 (disable)	00 (disable)	00 (disable)	00 (disable)	00 (disable)
Micro PDF 417 Length Control	00 (variable)	00 (variable)	00 (variable)	00 (variable)	00 (variable)	00 (variable)
Set Micro PDF 417 Length 1	0001	0001	0001	0001	0001	0001
Set Micro PDF 417 Length 2	016E	016E	016E	016E	016E	016E
Micro PDF 417 128 Emulation	00 (Micro PDF 417 AIM ID & label type)	00 (Micro PDF 417 AIM ID & label type)	00 (Micro PDF 417 AIM ID & label type)	00 (Micro PDF 417 AIM ID & label type)	00 (Micro PDF 417 AIM ID & label type)	00 (Micro PDF 417 AIM ID & label type)
QR Code	00 (disable)	00 (disable)	00 (disable)	00 (disable)	00 (disable)	00 (disable)
QR Code Length Control	00 (variable)	00 (variable)	00 (variable)	00 (variable)	00 (variable)	00 (variable)
Set QR Code Length 1	0001	0001	0001	0001	0001	0001
Set QR Code Length 2	0A96	0A96	0A96	0A96	0A96	0A96
QR Code URL Link Enable	00 (disable)	00 (disable)	00 (disable)	00 (disable)	00 (disable)	00 (disable)
GS1 QR Code Enable	00 (transmit as std QR Code label)	00 (transmit as std QR Code label)	01 (transmit as GS1 QR Code label)	00 (transmit as std QR Code label)	00 (transmit as std QR Code label)	00 (transmit as std QR Code label)
Micro QR Code	00 (disable)	00 (disable)	00 (disable)	00 (disable)	00 (disable)	00 (disable)
Micro QR Code Length Control	00 (variable)	00 (variable)	00 (variable)	00 (variable)	00 (variable)	00 (variable)
Set Micro QR Code Length 1	0001	0001	0001	0001	0001	0001
Set Micro QR Code Length 2	0E74	0E74	0E74	0E74	0E74	0E74
Aztec Code	00 (disable)	00 (disable)	00 (disable)	00 (disable)	00 (disable)	00 (disable)
Aztec Length Control	00 (variable)	00 (variable)	00 (variable)	00 (variable)	00 (variable)	00 (variable)

Feature	Default Master	RS-232	RS-232 Wincor-Nixdorf	Keyboard	USB COM / USB TEC	USB OEM
Set Aztec Length 1	0001	0001	0001	0001	0001	0001
Set Aztec Length 2	0E74	0E74	0E74	0E74	0E74	0E74

# APPENDIX E

## KEYBOARD FUNCTION KEY MAPPINGS

---

### USB Function Key Usage Map

ASCII	Key value	Usage Name	Modifier/Scancode
02	STX	F11	00h 44h
03	ETX	F12	00h 45h
04	EOT	GUI right Make	80h 00h
05	ENQ	GUI right Break	00h 00h
06	ACK	CTRL right Make	10h 00h
07	BEL	CTRL right Break	00h 00h
08	BS	BS	00h 2Ah
09	HT	TAB right	00h 2Bh
0A	LF	RIGHT arrow (inner keypad)	00h 4Fh
0B	VT	TAB left	02h 2Bh
0C	FF	Enter (right keypad)	00h 58h
0D	CR	CR	00h 28h
0E	SO	INSERT (inner keypad)	00h 49h
0F	SI	PAGE UP (inner keypad)	00h 4Bh
10	DLE	PAGE DOWN (inner keypad)	00h 4Eh
11	DC1	HOME (inner keypad)	00h 4Ah
12	DC2	LEFT arrow (inner keypad)	00h 50h
13	DC3	DOWN arrow (inner keypad)	00h 51h
14	DC4	UP arrow (inner keypad)	00h 52h
15	NAK	F6	00h 3Fh
16	SYN	F1	00h 3Ah
17	ETB	F2	00h 3Bh
18	CAN	F3	00h 3Ch
19	EM	F4	00h 3Dh
1A	SUB	F5	00h 3Eh
1B	ESC	ESC	00h 29h
1C	FS	F7	00h 40h

ASCII	Key value	Usage Name	Modifier/Scancode
1D	GS	F8	00h 41h
1E	RS	F9	00h 42h
1F	US	F10	00h 43h

The following keys can be optionally configured to correspond to the Rev C version of this function table. See "USB Keyboard Additional Interface Options" on page 77 to set this feature.

ASCII	Key value	Usage Name	Modifier/Scancode
02	STX	F11	00h 44h
03	ETX	F12	00h 45h
04	EOT	GUI right Make	80h 00h
05	ENQ	GUI right Break	00h 00h

### Scanset 1 Function Key Map

ASCII (hex)	ASCII code	Key	Scancode
02	STX	ALT left Make	38h
03	ETX	ALT left Break	B8h
04	EOT	CTRL left Make	1Dh
05	ENQ	CTRL left Break	9Dh
06	ACK	CTRL right Make	E0h 1Dh
07	BEL	CTRL right Break	E0h 9Dh
08	BS	BS	0Eh
09	HT	TAB right	0Fh
0A	LF	RIGHT arrow (inner keypad)	4Dh + E0
0B	VT	TAB left	0Fh + S
0C	FF	Enter (inner keypad)	1Ch + E0
0D	CR	CR	1Ch
0E	SO	INSERT (inner keypad)	52h + E0
0F	SI	PAGE UP (inner keypad)	49h + E0
10	DLE	PAGE DOWN (inner keypad)	51h + E0
11	DC1	HOME (inner keypad)	47h + E0
12	DC2	LEFT arrow (inner keypad)	4Bh + E0
13	DC3	DOWN arrow (inner keypad)	50h + E0
14	DC4	UP arrow (inner keypad)	48h + E0

## Scanset 2 Function Key Map

ASCII (hex)	ASCII code	Key	Scancode
02	STX	<b>ALT left Make</b>	11h
03	ETX	<b>ALT left Break</b>	F0h 11h
04	EOT	<b>CTRL left Make</b>	14h
05	ENQ	<b>CTRL left Break</b>	F0h 14h
06	ACK	<b>CTRL right Make</b>	E0h 14h
07	BEL	<b>CTRL right Break</b>	E0h F0h 14h
08	BS	<b>BS</b>	66h
09	HT	<b>TAB right</b>	0Dh
0A	LF	<b>RIGHT arrow (inner keypad)</b>	74h + E0
0B	VT	<b>TAB left</b>	0Dh + S
0C	FF	<b>Enter (right keypad)</b>	5Ah + E0
0D	CR	<b>CR</b>	5Ah
0E	SO	<b>INSERT (inner keypad)</b>	70h + E0
0F	SI	<b>PAGE UP (inner keypad)</b>	7Dh + E0
10	DLE	<b>PAGE DOWN (inner keypad)</b>	7Ah + E0
11	DC1	<b>HOME (inner keypad)</b>	6Ch + E0
12	DC2	<b>LEFT arrow (inner keypad)</b>	6Bh + E0
13	DC3	<b>DOWN arrow (inner keypad)</b>	72h + E0
14	DC4	<b>UP arrow (inner keypad)</b>	75h + E0
15	NAK	<b>F6</b>	0Bh
16	SYN	<b>F1</b>	05h
17	ETB	<b>F2</b>	06h
18	CAN	<b>F3</b>	04h
19	EM	<b>F4</b>	0Ch
1A	SUB	<b>F5</b>	03h
1B	ESC	<b>ESC</b>	76h
1C	FS	<b>F7</b>	83h
1D	GS	<b>F8</b>	0Ah
1E	RS	<b>F9</b>	01h
1F	US	<b>F10</b>	09h

### Scanset 3, 102-Key Function Key Map

ASCII (hex)	ASCII code	Key	Scancode
02	STX	ALT left Make	19h
03	ETX	ALT left Break	F0h 19h
04	EOT	CTRL left Make	11h
05	ENQ	CTRL left Break	F0h 11h
06	ACK	CTRL right Make	58h
07	BEL	CTRL right Break	F0h 58h
08	BS	BS	66h
09	HT	TAB right	0Dh
0A	LF	RIGHT arrow (inner keypad)	6Ah
0B	VT	TAB left	0Dh + S
0C	FF	Enter (inner keypad)	79h
0D	CR	CR	5Ah
0E	SO	INSERT (inner keypad)	67h
0F	SI	PAGE UP (inner keypad)	6Fh
10	DLE	PAGE DOWN (inner keypad)	6Dh
11	DC1	HOME (inner keypad)	6Eh
12	DC2	LEFT arrow (inner keypad)	61h
13	DC3	DOWN arrow (inner keypad)	60h
14	DC4	UP arrow (inner keypad)	63h
15	NAK	F6	2Fh
16	SYN	F1	07h
17	ETB	F2	0Fh
18	CAN	F3	17h
19	EM	F4	1Fh
1A	SUB	F5	27h
1B	ESC	ESC	08h
1C	FS	F7	37h
1D	GS	F8	3Fh
1E	RS	F9	47h
1F	US	F10	4Fh

### Scanset 3 122-Key Function Key Map

ASCII (hex)	ASCII code	Key	Scancode
02	STX	<b>ALT left Make</b>	19h
03	ETX	<b>ALT left Break</b>	F0h 19h
04	EOT	<b>CTRL left (RESET) Make only</b>	11h
05	ENQ	<b>CTRL left (RESET) Make/Break</b>	11h F0h 11h
06	ACK	<b>ONLINE Enter Make only</b>	58h
07	BEL	<b>ONLINE Enter Make/Break</b>	58h F0h 58h
08	BS	<b>BS</b>	66h
09	HT	<b>TAB right</b>	0Dh
0A	LF	<b>RIGHT arrow (inner keypad)</b>	6Ah
0B	VT	<b>TAB left</b>	0Dh + S
0C	FF	<b>CR (FIELD EXIT) Make only</b>	5Ah F0h 5Ah
0D	CR	<b>CR (FIELD EXIT) Make/Break</b>	5Ah
0E	SO	<b>INSERT (inner keypad)</b>	65h
0F	SI	<b>FIELD +</b>	79h
10	DLE	<b>FIELD -</b>	7Ch
11	DC1	<b>HOME (inner keypad)</b>	62h
12	DC2	<b>LEFT arrow (inner keypad)</b>	61h
13	DC3	<b>DOWN arrow (inner keypad)</b>	60h
14	DC4	<b>UP arrow (inner keypad)</b>	63h
15	NAK	<b>F6</b>	2Fh
16	SYN	<b>F1</b>	07h
17	ETB	<b>F2</b>	0Fh
18	CAN	<b>F3</b>	17h
19	EM	<b>F4</b>	1Fh
1A	SUB	<b>F5</b>	27h
1B	ESC	<b>ESC</b>	08h
1C	FS	<b>F7</b>	37h
1D	GS	<b>F8</b>	3Fh
1E	RS	<b>F9</b>	47h
1F	US	<b>F10</b>	4Fh

## Japanese DOS Function Key Map

ASCII value	ASCII code	Key	Scancode
02h	STX	ALT left Make	31h
03h	ETX	ALT left Break	B1h
04h	EOT	CTRL left Make	41h
05h	ENQ	CTRL left Break	C1h
06h	ACK	CTRL right Make	41h
07h	BEL	CTRL right Break	C1h
08h	BS	BS	3Eh
09h	HT	TAB right	3Ch
0Ah	LF	RIGHT arrow (inner keypad)	4Dh
0Bh	VT	TAB left	3Ch + S
0Ch	FF	Enter (right keypad)	60h
0Dh	CR	CR	3Bh
0Eh	S0	INSERT (inner keypad)	52h
0Fh	SI	PAGE UP (inner keypad)	49h
10h	DLE	PAGE DOWN (inner keypad)	51h
11h	DC1	HOME (inner keypad)	4Ch
12h	DC2	LEFT arrow (inner keypad)	4Bh
13h	DC3	DOWN arrow (inner keypad)	4Ah
14h	DC4	UP arrow (inner keypad)	4Eh
15h	NAK	F6	6Dh
16h	SYN	F1	68h
17h	ETB	F2	69h
18h	CAN	F3	6Ah
19h	EM	F4	6Bh
1Ah	SUB	F5	6Ch
1Bh	ESC	ESC	3Dh
1Ch	FS	F7	6Eh
1Dh	GS	F8	6Fh
1Eh	RS	F9	70h
1Fh	US	F10	71h



## NEC 9801-Key Function Key Map

ASCII value	ASCII code	Key	Scancode
00h	NUL	unused	n/a
01h	SOH	CR	1Ch
02h	STX	CAPS LOCK ON (make)	71h
03h	ETX	CAPS LOCK OFF (break)	F1h
04h	EOT	CTRL left Make	74h
05h	ENQ	CTRL left Break	F4h
06h	ACK	CTRL-C	60h
07h	BEL	n/a	n/a
08h	BS	BS	0Eh
09h	HT	TAB right	0Fh
0Ah	LF	RIGHT arrow (inner keypad)	3Ch
0Bh	VT	TAB left	0Fh + S
0Ch	FF	DELETE	39h
0Dh	CR	CR	1Ch
0Eh	SO	INSERT (inner keypad)	38h
0Fh	SI	KATAKANA LOCK ON (Make)	72h
10h	DLE	KATAKANA LOCK OFF (Break)	F2h
11h	DC1	HOME (inner keypad)	3Eh
12h	DC2	LEFT arrow (inner keypad)	3Bh
13h	DC3	DOWN arrow (inner keypad)	3Dh
14h	DC4	UP arrow (inner keypad)	3Ah
15h	NAK	F6	67h
16h	SYN	F1	62h
17h	ETB	F2	63h
18h	CAN	F3	64h
19h	EM	F4	65h
1Ah	SUB	F5	66h
1Bh	ESC	ESC	00h
1Ch	FS	F7	68h
1Dh	GS	F8	69h
1Eh	RS	F9	6Ah
1Fh	US	F10	6Bh

# APPENDIX F

## HOST COMMANDS

---

### ACCEPTING RS-232 COMMANDS

The scanner responds to the following RS-232 commands:

COMMAND	ASCII	HEX	COMMENT
Enable Scanner	E	0x45	
Disable Scanner	D	0x44	
Reset Scanner	R	0x52	
Not On File Indication	F	0x46	Long series of beeps
Beep Good Read Tone	B	0x42	Beeps if Good Read Beep is enabled
Force Good Read Tone	!	0x01	Beeps regardless of beep setting
Identification request	i	0x69	Returns long response <sup>a</sup>
Health request	h	0x68	Returns long response <sup>a</sup>
Status request	s	0x73	Returns long response <sup>a</sup>
Beep on ASCII BEL	!	0x07	Beeps if Beep on ASCII BEL is enabled

a. Call Tech Support for information.

If one of the above commands is received, the scanner will perform the steps indicated for the command. Host commands for other interfaces are also available. Contact Tech Support for more details.

Also see the section "[Image Capture to the Host by Host Command](#)" on page 90 for details concerning that feature.

# APPENDIX G

## SAMPLE SYMBOLS

---

### 1D SYMBOL SAMPLES

UPC-A

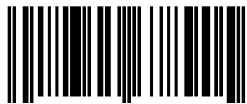

0 1234567890

Interleaved 2 of 5



1234567890

Code 128



Code 128

EAN-13

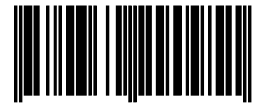

9 780330 290951

Code 39

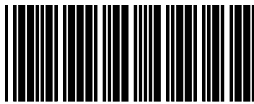

BC321

Codabar

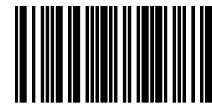

A13579B

Code 93



123456-9\$

### 1D Symbols (continued)

Code 2 of 5

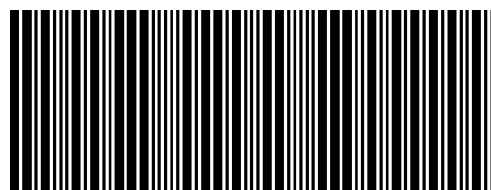

123456

GS1 DataBar Omnidirectional



(01)00123456789012

GS1 DataBar Expanded



0100123456789050

GS1 DataBar Limited



(01)16543210987654

# 2D SAMPLE SYMBOLS

PDF 417

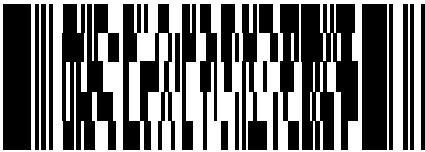

A12B3C

Micro PDF 417

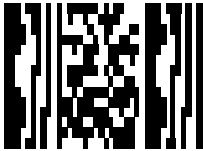

BV17453

Datamatrix

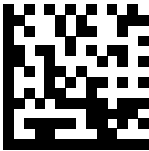

1314H17LL

QR Code

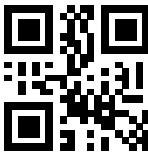

35900G9

Micro QR Code



ABCDEF

Aztec



This is an Aztec Code

# COMPOSITE SAMPLE SYMBOLS

GS1 DataBar Limited Composite

(17) 050923 (10) ABC123



(01) 0 4012345 67890 1

GS1 DataBar Truncated Composite

(17)050923(10)ABC123



(01) 09876543217899

# APPENDIX H

## MICROSD CARD

---

<b>MICROSDHC COMPATIBILITY</b> <a href="#">starting on page 286</a> <ul style="list-style-type: none"><li>• <a href="#">microSD Card Insertion</a></li><li>• <a href="#">microSD Card Removal</a></li></ul>
<b>AUTORUN FILE PROCESSING</b> <a href="#">starting on page 287</a>
<b>MICROSD FUNCTION SUMMARY</b> <a href="#">starting on page 287</a>
<b>MICROSD FUNCTION DETAILS</b> <a href="#">starting on page 288</a> <ul style="list-style-type: none"><li>• <a href="#">From Scanner to microSD Card</a></li><li>• <a href="#">From microSD Card to Scanner</a></li></ul>

## MICROSDHC COMPATIBILITY

At the time of this writing, the microSD card interface for this product supports SD-Memory Card Specifications/ Part 1. Physical Layer Specification; Version 1.01, but the processor MCI can communicate with SDHC Cards. For example, the scanner can perform the functions specified in this appendix for the SDA 2.0 specification. Both FAT16 and FAT32 formats are supported.

Filenames are limited to the 8.3 file naming format (i.e., FILENAME . EXT), and MUST be capitalized.

### microSD Card Insertion

1. Read all of these instructions before starting.
2. If you have not already done so, remove the scanner from its installed position to allow access to the microSD card slot.
3. Separate the scanner from its back cover.
4. Ensure there are no other cables attached to the scanner, then apply power and wait for the reset beep.
5. Lift and rotate the rubber cover to access the card slot, then carefully insert the microSD card into the slot until it "clicks" into place.

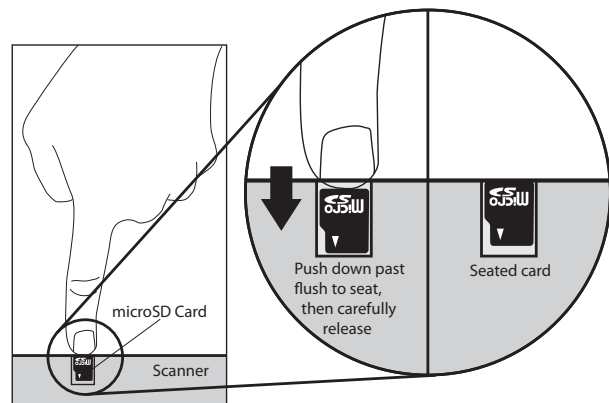

**CAUTION:** The microSD card slot is spring loaded. Keep your finger lightly in place atop the card until you are sure it is fully seated in place. See the illustration on the following page.

Use your finger or thumbnail to push in on the top edge of the card to be slightly below flush with the scanner enclosure when inserting or removing the card. This will engage/disengage the spring mechanism.

**Never insert tools or other foreign objects into the microSD card slot.**

6. If installed properly, you should immediately hear an audible signal upon insertion or removal of a microSD card. Various operations will also be indicated by the scanner's good read LED.

### microSD Card Removal

1. Push in gently using your finger or thumbnail to disengage and remove the microSD card. Remember to keep your finger in place atop the card's edge to avoid accidentally "launching" the card from the spring-loaded slot.
2. Reconnect all cables which were disconnected earlier.



## AUTORUN FILE PROCESSING

After insertion of the card, the scanner will mount the microSD card and search for the file “**AUTORUN.DLS**”. Embedded in that file is a validation pattern of the ASCII strings “\$START\$” and “\$END\$” located at the respective starting and ending of the file.

If the validation pattern is found, the file may contain any of the following commands. The scanner will parse the file taking action according to these commands. Filenames in this format specify a user-defined name.

Example AUTORUN.DLS file:

```
$START$(required)
CONFIG, FILENAME . TEX
DUMPSTATS, FILENAME . TXT
DUMPCFG, FILENAME . TEX
LOADSW, FILENAME . S37
$END$ (required)
```

## MICROSD FUNCTION SUMMARY

The following table summarizes various functions of microSD card. Contact tech support regarding upgrade license for new features.

FUNCTION		Export Status	Export Configuration	Load Applic	Load Config	Load CPLD Code <sup>a</sup>	Feature Upgrade <sup>b</sup>
Direction	Scanner ⇒ microSD Card	√	√				
	microSD Card ⇒ Scanner			√	√	√	√
Initiated by	Scanning a label			√	√		
	AUTORUN.DLS file in microSD card	√	√	√	√	√	√

- a. The only way to load CPLD code (i.e., FPGA code) is to load a new application package.
- b. The only way to do a feature upgrade is to load a new application package.

# MICROSD FUNCTION DETAILS

## From Scanner to microSD Card

### Capture and save an image to a microSD card by button press

1. Insert the secure microSD card into the scanner.
2. Place the item to be captured in front of the scanner.
3. Press and release the Camera Button for one second. The scanner will automatically capture and save the image to the microSD card.
4. The scanner will emit an audible signal when complete, and the image is saved to the microSD card.



**NOTE: The microSD card must contain a secure file to save images. Contact Customer Support for more details about this feature.**

**The image file name range is from image-1 to image-999. If the same name already exists in the microSD card, the scanner skips that name and uses the next.**

**Image format (.BMP, .JPG), image size (VGA, WVGA, Full size), Brightness (0~9), contrast (0~9), and JPG compression ratio (0~100) are defined in configuration.**

### Export a Configuration file from the Scanner to the microSD card

#### By AUTORUN.DLS file

1. Generate a text file by any text editor as follows and save it as AUTORUN.DLS .

```
$START$
```

```
DUMPCFG,SDCONFIG.TEX (Filename can be anything, for example  
"SOMETHING.TEX")
```

```
$END$
```

2. Save or copy file AUTORUN.DLS to microSD card
3. Insert the microSD card to scanner.
4. Wait for 3 seconds,

A scanner configuration file named SDCONFIG.TXT is saved to the microSD card.

## From microSD Card to Scanner

### Application code load to scanner

#### By AUTORUN.DLS file

1. Generate a text file by any text editor as follows and save it as `AUTORUN.DLS`  
`$START$`  
`LOADSW,R96-APP1.S37`  
`$END$`
2. Save or copy file `AUTORUN.DLS` to microSD card and copy the application code (example `R96-APP1.S37`) to the microSD card.
3. Insert the microSD card into the scanner.
4. Upon scanner audio indication of completion, the application code `R96-APP1.S37` is loaded to the scanner. Typically, this takes about 45 seconds.

### Configuration load to scanner

#### By Autorun file

1. Generate a text file by any text editor as follows and save it as `AUTORUN.DLS`  
`$START$`  
`CONFIG,R96-CFG1.TEX`  
`$END$`
2. Save or copy the `autorun.dls` file, and copy the CPLD code (example `R96-CFG1.TEX`) to the microSD card.
3. Insert the microSD card into the scanner.
4. Upon scanner audio indication of completion, configuration `R96-CFG1.TEX` is loaded to the scanner.

# APPENDIX I

## HANDHELD DATA FORMAT REQUIREMENTS

---

This appendix provides application notes to describe the general format of data that can be accepted by the scanner from a handheld scanner connected via the USB port.

### HANDHELD DATA FORMAT REQUIREMENTS GENERAL

- USB handhelds enumerate as a CDC ACM serial device.
- USB devices should also bracket the data with the RTS equivalent.
- The time between character transmission can be no longer than 50 milliseconds.
- Symbologies requiring fixed lengths (UPC/EAN) will enforce length requirements for validation of the label.
- Handheld will be required to transmit start and stop characters for Codabar and Code39 labels.
- Appropriate industrial length requirements will be enforced (if configured) for validation of the label.
- Maximum label lengths will be enforced for label validation (i.e. labels longer than the maximum label size will not be validated).
- Standard Datalogic formats generally use a single prefix character. see specific formats section.
- Maximum label size allowed including identifiers is 2714 bytes
- Recommendations:
  - Handheld should not be configured for audible label read indication.
  - Handheld should not be configured for visual label read indication.
  - Handheld should not be configured for continuous label read mode.

### Datalogic Handheld Data Format Requirements

The following sections describe label transmission formats that are typically observed in factory configurations of Datalogic handheld scanners.

#### GS1 DataBar Omnidirectional

- Prefix must be ASCII characters 'R4'
- Check character must be included in label
- Application identifier "01" must follow the prefix and precede the base label
- Label length excluding prefix characters must be 16 characters.
- Example: 'R40101044123456789'

## GS1 DataBar Expanded

- Prefix must be ASCII characters 'R4'
- Check character must be included in label

## UPC-A

- Number system must be included in label data.
- Check digit must be included in label data and is assumed to be correct.
- Prefix must be an ASCII character 'A' - total length including prefix must be 13.
- Example: 'A060992011187'.

## UPC-A with 2-Digit Supplemental

- Number system must be included in label data.
- Check digit must be included in label data and is assumed to be correct.
- Supplemental data is appended to base label.
- Prefix must be an ASCII character 'A' - total length including prefix must be 15.
- Example: 'A06099201118712'.

## UPC-A with 5-Digit Supplemental

- Number system must be included in label data
- Check digit must be included in label data and is assumed to be correct
- Prefix must be an ASCII character 'A' - total length including prefix must be 18
- Example: 'A06099201118712345'

## UPC-E

- Number system must be included in label data
- Check digit must be included in label data and is assumed to be correct
- Prefix must be an ASCII character 'E' - total length including prefix must be 9
- Example: 'E09988750'

## UPC-E with 2-Digit Supplemental

- Number system must be included in label data.
- Check digit must be included in label data and is assumed to be correct.
- Supplemental data is appended to base label.
- Prefix must be an ASCII character 'E' - total length including prefix must be 11.
- Example: 'E0998875012'.

## UPC-E with 5-Digit Supplemental

- Number system must be included in label data.
- Check digit must be included in label data and is assumed to be correct.
- Prefix must be an ASCII character 'E' - total length including prefix must be 14.
- Example: 'E0998875012345'.

## EAN-8

- Check digit must be included in label data and is assumed to be correct
- Prefix must be an ASCII characters 'FF' - total length including prefix must be 10
- Example: 'FF00210126'

## EAN-8 with 2-Digit Supplemental

- Check digit must be included in label data and is assumed to be correct.

- Supplemental data is appended to base label.
- Prefix must be an ASCII characters 'FF' - total length including prefix must be 12.
- Example: 'FF0021012612'.

### **EAN-8 with 5-Digit Supplemental**

- Check digit must be included in label data and is assumed to be correct.
- Prefix must be an ASCII characters 'FF' - total length including prefix must be 15.
- Example: 'FF0021012612345'.

### **EAN-13**

- Check digit must be included in label data and is assumed to be correct
- Prefix must be an ASCII character 'F' - total length including prefix must be 14
- Example: 'F1101234567891'

### **EAN-13 with 2-Digit Supplemental**

- Check digit must be included in label data and is assumed to be correct
- Supplemental data is appended to base label
- Prefix must be an ASCII character 'F' - total length including prefix must be 16
- Example: 'F110123456789112'

### **EAN-13 with 5-Digit Supplemental**

- Check digit must be included in label data and is assumed to be correct.
- Prefix must be an ASCII character 'F' - total length including prefix must be 19.
- Example: 'F110123456789112345'.

### **Code 39**

- Check character must be included in label data.
- Label length including start, stop and check characters and excluding prefix character must meet requirements imposed by the main scanner's fixed or variable label length control for this symbology type.
- Start and stop characters "\*" must be included in label.
- Prefix must be an ASCII character '\*'.
- Example: '\*\*Code 39.TEST\*'.

### **Code 39-Pharmacode**

- Check character must be included in label data.
- Label length including start, stop and check characters and excluding prefix character must meet requirements imposed by the main scanner's fixed or variable label length control for this symbology type.
- Start and stop characters "\*" must be included in label.
- Prefix must be an ASCII character 'p'.
- Example: 'p\*123456789\*'.

### **I 2 of 5**

- Check character must be included in label data.
- Label length including check characters and excluding prefix character must meet requirements imposed by the main scanner's fixed or variable label length control for this symbology type.
- Prefix must be an ASCII character 'i'.
- Example: 'i0123456789'.

## Codabar

- Check character must be included in label data.
- Label length including check character and excluding prefix character must meet requirements imposed by the main scanner's fixed or variable label length control for this symbology type.
- Prefix must be an ASCII character '%'.
- Start stop character sets must meet the matching requirement set forth by the scanner configuration item *Start/Stop Character Match*.
- Start stop character sets must be of the form ABCD/ABCD and must be included in the label.
- Example: '%s\$99.95s' (the lower case 's' at each end of the example is a placeholder for the start stop character set).

## Code 128

- Prefix must be an ASCII character '#'.
- Label length excluding prefix character or function code 3 for Code 128 programming labels must meet requirements imposed by the main scanner's fixed or variable label length control for this symbology type.
- Function characters may be transmitted as a hexadecimal value 8x. Where x correlates to function characters 1 thru 4 as follows:
  - x80 = function code 1
  - x81 = function code 2
  - x82 = function code 3
  - x83 = function code 4
- For Code 128 programming labels the format is of the general form '#/82nnnnn/r' - /82 is hexadecimal 82 and /r is carriage return.
- Example: '#Code\_128.Test'.

## MSI

- Check character must be included in label data.
- Label length including check character and excluding prefix character must meet requirements imposed by the main scanner's fixed or variable label length control for this symbology type.
- Prefix must be an ASCII character '@'.
- Example: '@144769254'.

## Code 93

- Prefix must be an ASCII character '&'.
- Label length excluding prefix character must meet requirements imposed by the main scanner's fixed or variable label length control for this symbology type.
- Example: '&Code93-test'.

## PDF417

- Prefix must be an ASCII character 'P'.
- Label length excluding prefix character cannot exceed 300 characters. In addition to this, label length excluding prefix character must meet requirements imposed by the main scanner's fixed or variable label length control for this symbology type.

## AIM Formats

AIM specifies a 3-character string that is attached as a prefix to the label data for transmission. Because AIM specifies one identifier for UPC-A, UPC-E and EAN-13 labels, UPC-A, UPC-E and EAN-13 will be received from the handheld and transmitted by the scanner as EAN-13. The ']' character must be the first character received in the label transmission from the handheld.

The following sections describe the prefix strings and identify what specific label characteristics can be supported.

### UPC-A

- AIM does not specify UPC-A as a separate symbology using this transmission format - labels will be transmitted as EAN-13.
- Example: ']E00060992011187'.

### UPC-E

- AIM does not specify UPC-E as a separate symbology using this transmission format - labels will be transmitted as EAN-13.
- Example: ']E00000000998875'.

### EAN-13

- Check digit must be included in label data and is assumed to be correct.
- Prefix must be ASCII characters ']E0' - total length including prefix must be 16.
- Example: ']E01101234567891'.

### EAN-8

- Check digit must be included in label data and is assumed to be correct.
- Prefix must be ASCII characters ']E4' - total length including prefix must be 11.
- Example: ']E400210126'.

### 2-Digit Supplemental

- Supplemental data is appended to any EAN base label.
- Prefix must be ASCII characters ']E1'.
- length of Supplemental data including prefix must be 5. Total required length is 21 for EAN-13 and 16 for EAN-8.
- Examples: add-on portion is highlighted data is underlined.

UPC-A 2-Digit add-on	]E00060992011187 <u>JE112</u> '
UPC-E 2-Digit add-on	]E00000000998875 <u>JE112</u> '
EAN-8 2-Digit add-on	]E400210126 <u>JE112</u> '
EAN-13 2-Digit add-on	]E01101234567891 <u>JE112</u> '

### 5-Digit Supplemental

- Supplemental data is appended to any EAN base label.
- Prefix must be ASCII characters ']E2'.
- Length of supplemental data including prefix must be 8. Total required length is 24 for EAN-13 and 19 for EAN-8.
- Examples: add-on portion is highlighted data is underlined.



UPC-A 5-Digit add-on	']E00060992011187]E2_12345'
UPC-E 5-Digit add-on	']E00000000998875]E2_12345'
EAN-8 5-Digit add-on	']E400210126]E2_12345'
EAN-13 5-Digit add-on	']E01101234567891]E2_12345'

## Bookland

- The 'Bookland' / ISBN code will be formatted as a vendor specific AIM label.
- Prefix must be ASCII characters ']X0'.
- length of label data including prefix is 13.
- Examples: ']X01234567890'.

## Code 39

- Check character must be included in label data.
- Label length including start, stop and check characters and excluding prefix characters must meet requirements imposed by the main scanner's fixed or variable label length control for this symbology type.
- Start and stop characters "\*" must be included in label.
- Prefix must be ASCII characters ']A0' or ']A1'.
- Example: '\*]A0Code 39.TEST\*'.

## Codabar

- Check character must be included in label data.
- Label length including check character and excluding prefix characters must meet requirements imposed by the main scanner's fixed or variable label length control for this symbology type.
- Prefix must be ASCII characters ']F0'.
- Start stop character sets must meet the matching requirement set forth by the scanner configuration item *Start/Stop Character Match*.
- Start stop character sets s must be of the form ABCD/ABCD and must be included in the label.
- Example: ']F0s\$99.95s' (the lower case 's' at each end of the example is a placeholder for the start stop character set).

## MSI

- Check character must be included in label data.
- Label length including check character and excluding prefix characters must meet requirements imposed by the main scanner's fixed or variable label length control for this symbology type.
- Prefix must be ASCII characters ']M0'.
- Example: ']M0144769254'.

## Code 93

- Prefix must be ASCII characters ']G0'.
- Label length excluding prefix characters must meet requirements imposed by the main scanner's fixed or variable label length control for this symbology type.
- Example: ']G0Code93-test'.

## RSS-14

- Prefix must be ASCII characters ']e0'.
- Check character must be included in label.
- Label length excluding prefix characters must be 14 characters.
- Example: ']e001044123456789'.

## RSS Expanded

- Prefix must be ASCII characters ']e0'.
- Label length excluding prefix characters must be at least 1 character. Maximum length is the maximum label size supported by the scanner.
- Example: ']e001900123456789083103001750'.

## I 2 of 5

- Check character must be included in label data.
- Label length including check characters and excluding prefix characters must meet requirements imposed by the main scanner's fixed or variable label length control for this symbology type.
- Prefix must be an ASCII character ']I1' (other prefixes specify different check character properties which are not supported).
- Example: ']I10123456789'.

## Code 128 / EAN128

- Prefix must be either ASCII characters ']C0', ']C1' or ']C2'.
- Label length excluding prefix character must meet requirements imposed by the main scanner's fixed or variable label length control for this symbology type.
- If EAN-128 Symbology is Enabled and prefix is ']C1', label will be identified as an EAN128 otherwise it is identified as a Code 128.
- A prefix of ']C0' designates that no function code is present in the 1st or 2nd character position.
- A prefix of ']C2' designates that a function code 1 is present in the 2nd character.
- Example: ']C0Code\_128.Test'.

## PDF417

- Prefix must be an ASCII characters ']L0'.
- Label length excluding prefix character cannot exceed 300 characters. In addition to this, label length excluding prefix character must meet requirements imposed by the main scanner's fixed or variable label length control for this symbology type.
- Example: ']L0pdf\_test\_label'.

## “Unknown” AIM ID (an AIM ID which is not specified above)

If a label is received that does not have an AIM ID as specified above, and the first three label characters qualify as follows...

- The first character is a ']'
- The second character is a capital or small letter
- The third character is a digit

...then the label type is set to GENERIC\_DATA and the “unknown” AIM ID is left-appended to the beginning of the label data.

# APPENDIX J

## ASCII CHART

---

ASCII Char.	Hex No.	ASCII Char.	Hex No.	ASCII Char.	Hex No.	ASCII Char.	Hex No.
NUL	00	SP	20	@	40	'	60
SOH	01	!	21	A	41	a	61
STX	02	"	22	B	42	b	62
ETX	03	#	23	C	43	c	63
EOT	04	\$	24	D	44	d	64
ENQ	05	%	25	E	45	e	65
ACK	06	&	26	F	46	f	66
BEL	07	'	27	G	47	g	67
BS	08	(	28	H	48	h	68
HT	09	)	29	I	49	i	69
LF	0A	*	2A	J	4A	j	6A
VT	0B	+	2B	K	4B	k	6B
FF	0C	,	2C	L	4C	l	6C
CR	0D	-	2D	M	4D	m	6D
SO	0E	.	2E	N	4E	n	6E
SI	0F	/	2F	O	4F	o	6F
DLE	10	0	30	P	50	p	70
DC1	11	1	31	Q	51	q	71
DC2	12	2	32	R	52	r	72
DC3	13	3	33	S	53	s	73
DC4	14	4	34	T	54	t	74
NAK	15	5	35	U	55	u	75
SYN	16	6	36	V	56	v	76
ETB	17	7	37	W	57	w	77
CAN	18	8	38	X	58	x	78
EM	19	9	39	Y	59	y	79
SUB	1A	:	3A	Z	5A	z	7A
ESC	1B	;	3B	[	5B	{	7B
FS	1C	<	3C	\	5C		7C
GS	1D	=	3D	]	5D	}	7D
RS	1E	>	3E	^	5E	~	7E
US	1F	?	3F	_	5F	DEL	7F

© 2016-2022 Datalogic S.p.A. and /or its affiliates • All rights reserved • Without limiting the rights under copyright, no part of this documentation may be reproduced, stored in or introduced into a retrieval system, or transmitted in any form or by any means, or for any purpose, without the express written permission of Datalogic S.p.A. and/or its affiliates • Datalogic and the Datalogic logo are registered trademarks of Datalogic S.p.A. in many countries, including the U.S. and the E.U.

 **DATALOGIC**  
[www.datalogic.com](http://www.datalogic.com)

**Datalogic S.r.l.**

Via S. Vitalino, 13 | 40012 Calderara di Reno | Bologna - Italy  
Tel. +39 051 3147011 | Fax +39 051 3147205



820124500

(Rev D)

April 2022