

DC-to-DC Power Supply Installation Instructions

For use with the models listed below. These models can be identified by a lid with screws on the top of the lid. These models listed below may be obsolete.

VX89301PWRSPLY – Power Supply, DC/DC, 9 to 36V

VX89A302PSDC48V – Power Supply, DC/DC, 18 to 60V

VX89303PWPSPLY – Power Supply, DC/DC, 60 to 110V

9000301PWRSPLY – Power Supply, 18-60VDC with cable

9000302PWRSPLY – Power Supply, 60-110VDC with cable

These models may be used to replace the obsolete power supplies. Contact Honeywell Technical Support or go to www.honeywellaidc.com for DC/DC power supply installation instructions for the replacement models listed below.

9000311PWRSPLY – Power Supply, 9-60VDC, 60W

9000313PWRSPLY – Power Supply, 50-150VDC, 60W

Connecting electrical cables to power sources

The DC-to-DC power supply is used to power certain vehicle-mount computers (VMCs) or to provide vehicle power to certain hand-held computers (HHCs) when placed in a DC powered vehicle dock or cradle.

Specifications for electrical supply	
Input Voltage	Always observe input voltage range specified on the DC-to-DC power supply and the optional screen blanking box (for vehicle mounted terminals only).
Output Voltage	12 VDC \pm 10%
Power	75 W
Fuse	Tecton, MX9, MX3 Plus, MX7: Use a 5 A slow blow fuse.
	Thor VX8, Thor VX9, Marathon: Use a 10 A slow blow fuse
	Thor VM1, Thor VM2, Thor VM3: Use VM3055FUSE (or equivalent) to install the fuse as shown below: <ul style="list-style-type: none"> • For 12VDC input, use the 10A fuse from the kit or a slow blow fuse that has a DC voltage rating greater than 12VDC. • For 24VDC input, use the 6A fuse from the kit or a slow blow fuse that has a DC voltage rating greater than 24VDC. • For 36VDC input, use the 4A fuse from the kit or a slow blow fuse that has a DC voltage rating greater than 36VDC. • For 48VDC input, use the 3A fuse from the kit or a slow blow fuse that has a DC voltage rating greater than 48VDC.
	Screen Blanking Box: Use a 3 A fuse





Please refer to the appropriate wiring schematic on the following pages for wiring colors and connections:

Figures 1a and 1b – Thor VX8 and Thor VX9 Vehicle Mounted Computers

Figures 2a and 2b – Thor VM1, Thor VM2 and Thor VM3 Vehicle Mounted Computers

Figure 3 – Marathon Vehicle Dock

Figure 4 – MX3Plus, MX7, MX7 Tecton and MX9 Vehicle Mounted Cradles

Caution: 	For proper and safe installation, the input power cable must be connected to a fused circuit on the vehicle. This fused circuit requires a user supplied 5 or 10 Amp maximum time delay (slow blow, see table above for fuse rating) high interrupting rating fuse. If the supply connection is made directly to the battery, the fuse should be installed in the positive lead within 5 inches of the battery positive (+) terminal.
Caution 	The VX power supplies are sealed per IPXX. Usage in areas where moisture can affect the power supply connections should be avoided. The power supply should be mounted in a dry location within the vehicle or placed in a suitable protective enclosure.
Caution: 	For installation by trained service personnel only.
Warning: 	Risk of ignition or explosion. Explosive gas mixture may be vented from battery. Work only in well ventilated area. Avoid creating arcs and sparks at battery terminals.

Connecting the Vehicle Electrical Connection

Please review the proper wiring illustration, later in this document, before beginning power cable install. If connecting a VMC, the computer must be powered off. If connecting a HHC cradle/dock, the cradle must be empty.

1. Connect the power cable to the VMC or the HHC cradle.
2. Route the cable from the VMC or HHC cradle to the DC-to-DC converter and, optionally for some VMCs, to the screen blanking box.
3. Cut the cable to length and strip the wire ends. If the screen blanking feature is not used for the Thor VX8 or Thor VX9, do not strip the green and yellow wires.
4. Route the power cable the shortest way possible. The cable is rated for a maximum temperature of 105°C (221°F). When routing this cable, it should be protected from physical damage and from surfaces that might exceed this temperature. Do not expose the cable to chemicals or oil that may cause the wiring insulation to deteriorate. Always route the cable so that it does not interfere with safe operation and maintenance of the vehicle.
5. Remove the lid from the DC-to-DC converter.
6. Strip the ends of the wires in the cable from the VMC or HHC cradle and attach the wire ends to the output side of the DC-to-DC converter.
7. Strip the ends of the wires in the cable that will connect to vehicle power and attach the wire ends to the input side of the DC-to-DC converter.

Note: The input and output blocks each have two + and two – minus connectors. Either connector in the block can be used to connect the matching polarity wire.

The input and output blocks also each have two ⊕ (chassis ground) connections. When the diagram indicates a chassis ground connection, use either chassis ground connector in each block.

Note: Wire colors depend on the type of device attached. Please refer to the illustrations later in this document for wire colors.

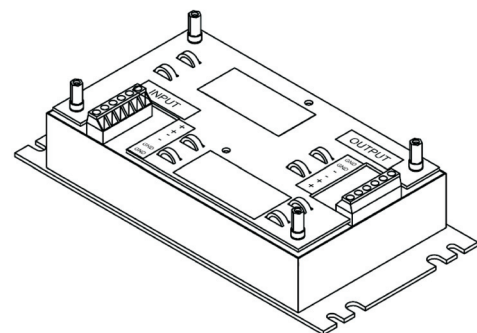

8. Use looms and wire ties to secure all wiring as shown.
9. Reattach the cover with the screws.
10. If the screen blanking box is used for a Thor VX8 or Thor VX9 installation, attach the stripped green and yellow wire ends to the box. Refer to the applicable following diagram for proper wiring connection.
11. If the screen blanking box is used for a Thor VM1 or Thor VM2 installation, connect a serial cable from the COM port on the Mount Smart Dock to the box. Refer to the applicable following diagram for proper wiring connection.
12. Connect the DC-to-DC converter to the vehicle's electrical system.

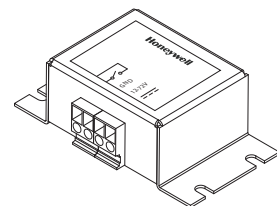

Caution: 	For battery powered vehicles: + is connected to battery positive. - must be connected to battery negative. GND ⊕ must be connected to the vehicle chassis ground.	For internal combustion engine powered vehicles: + is connected to battery positive. - is connected to battery negative. GND ⊕ is connected to the vehicle chassis ground, which can also be battery negative.

13. While observing the fuse requirements specified above, connect the power cable as close as possible to the actual battery terminals of the vehicle. When available, always connect to unswitched terminals in the vehicle fuse panel, after providing proper fusing.

ATTENTION: For uninterrupted power, electrical supply connections should not be made at any point after the ignition switch of the vehicle.

14. If the screen blanking box is used for a VMC installation, connect the box to vehicle motion circuitry and ground. Refer to the applicable following diagram and the label on the screen blanking box for proper wiring connection.
15. Use proper electrical and mechanical fastening means for terminating the cable. Properly sized “crimp” type electrical terminals are an accepted method of termination. Select electrical connectors sized for use with 18AWG (1mm²) conductors.
16. Provide mechanical support for the cable by securing it to the vehicle structure at approximately one foot intervals, taking care not to over tighten and pinch conductors or penetrate the outer cable jacket.

Figure 1a – Thor VX8 and Thor VX9 Vehicle Mounted Computers

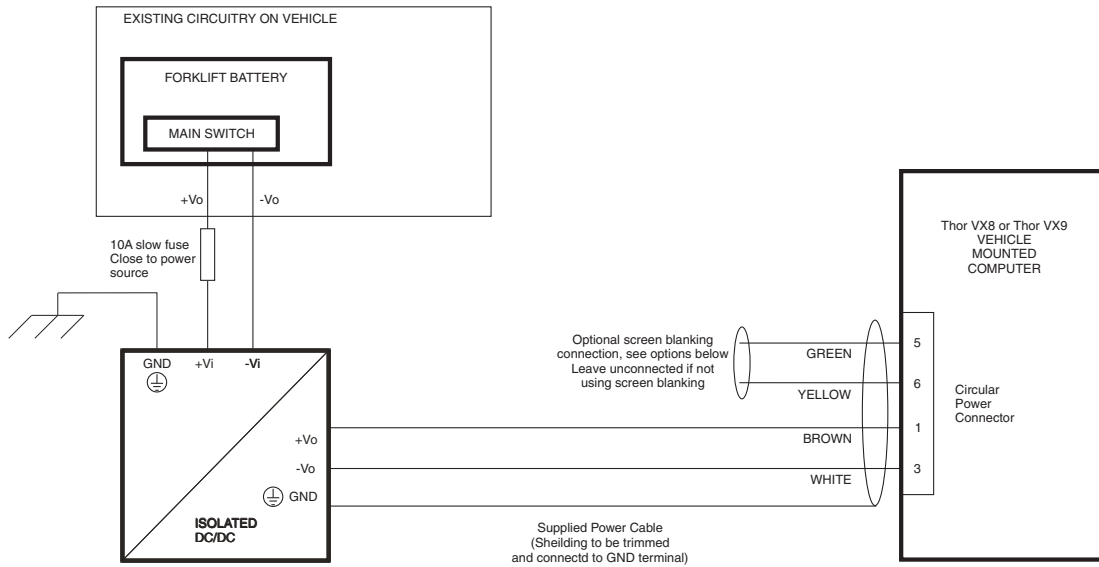
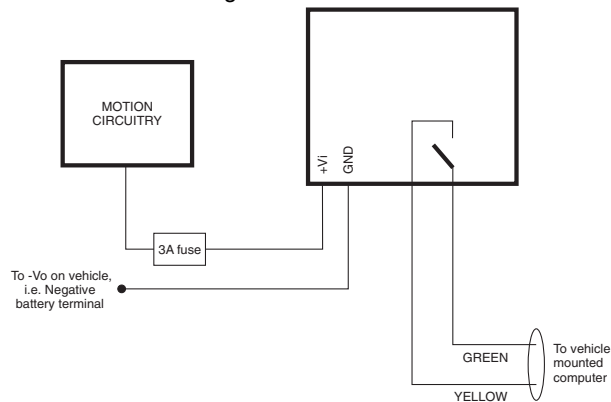

Figure 1b – Optional Screen Blanking Connections

Screen blanking is configured via the Display Backlight tab of the VMT Manager option in the Windows Control panel.

With Screen Blanking Box



Connect to existing motion circuitry on vehicle – any 12-60 or 12-72 VDC signal triggered by vehicle motion.

Refer to the label on the Screen Blanking Box for allowable voltage input range.

With User Supplied Switch / Relay

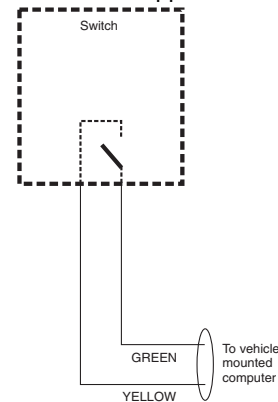

User supplied switch/relay that supplies electrical conductive connection on vehicle motion

Figure 2a – Thor VM1, Thor VM2, and Thor VM3 Vehicle Mounted Computers

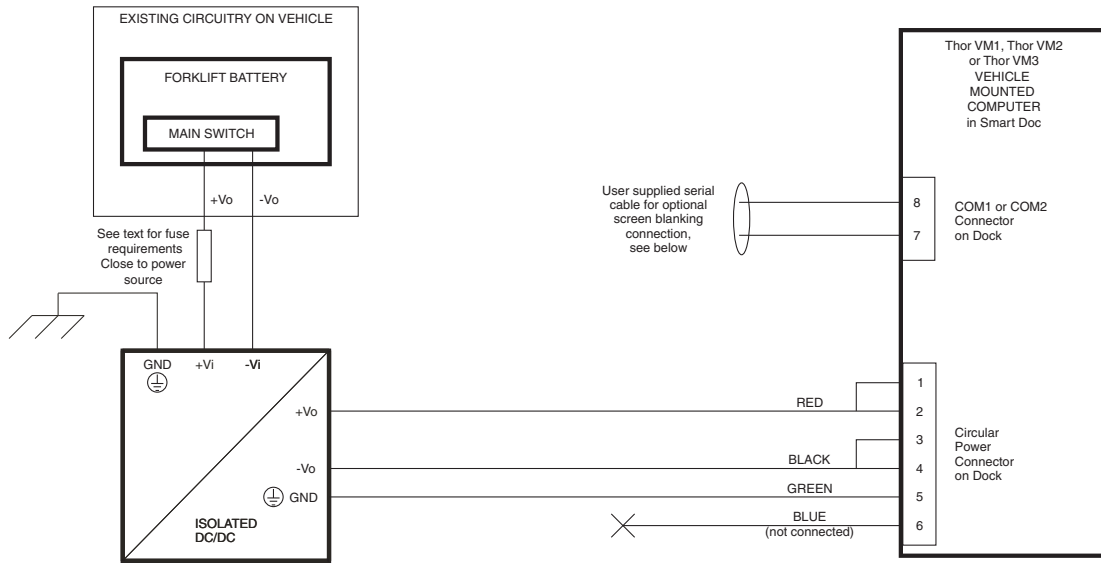
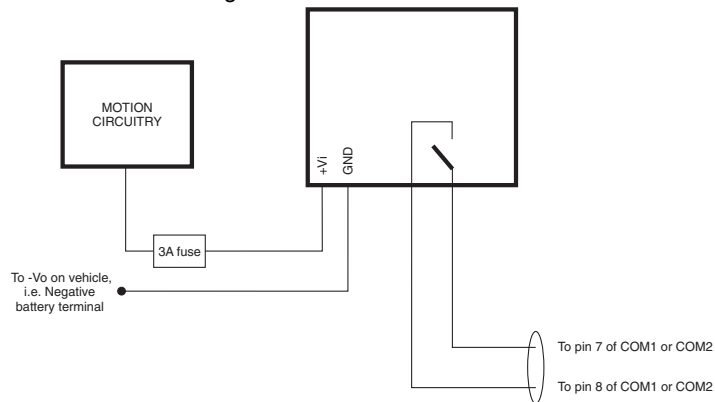

Figure 2b – Optional Screen Blanking Connections

The user must supply the serial cable for the screen blanking connection. Only pins 7 and 8 are used for the screen blanking connection. Screen Blanking is configured via the Screen Control (Thor VM1 and Thor VM2) or the ZoomZone (Thor VM3) option in the Windows Control Panel.

With Screen Blanking Box



Connect to existing motion circuitry on vehicle – any 12-60 or 12-72 VDC signal triggered by vehicle motion.

Refer to the label on the Screen Blanking Box for allowable voltage input range.

Connect switched terminal on blanking box to Pin 7 of COM port.

With User Supplied Switch / Relay

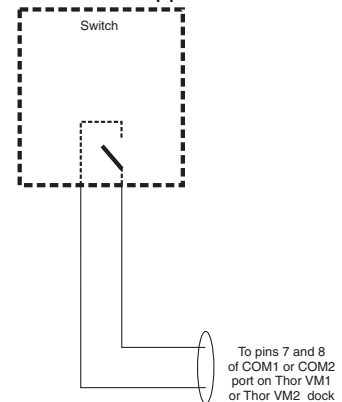

User supplied switch/relay that supplies electrical conductive connection on vehicle motion

Figure 3 – Marathon Vehicle Dock

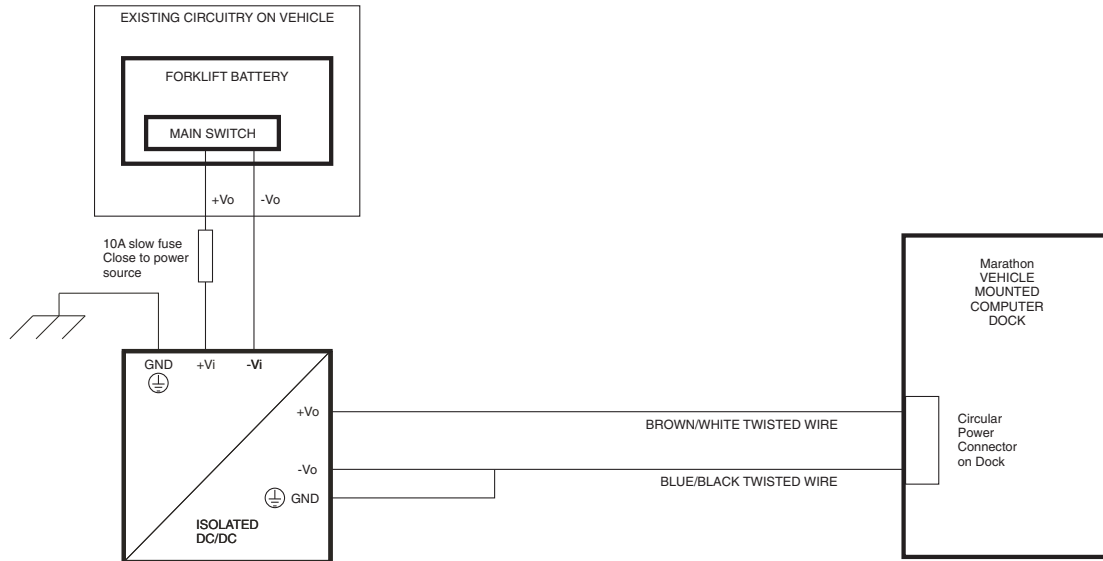

Separate the blue/black twisted wires.

Connect one of the wires to a $-Vo$ terminal and the other to a \oplus (chassis ground) terminal on the DC-to-DC power supply.

Figure 4 – MX3Plus, MX7, MX7 Tecton and MX9 Vehicle Cradles

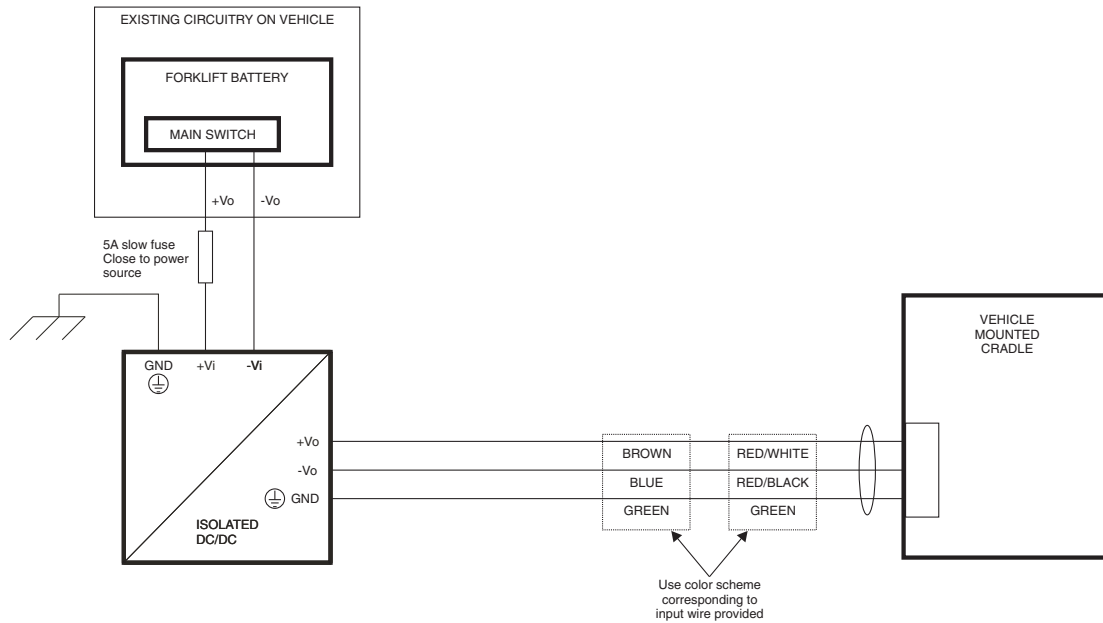

Disclaimer

Honeywell International Inc. (“HII”) reserves the right to make changes in specifications and other information contained in this document without prior notice, and the reader should in all cases consult HII to determine whether any such changes have been made. The information in this publication does not represent a commitment on the part of HII.

HII shall not be liable for technical or editorial errors or omissions contained herein; nor for incidental or consequential damages resulting from the furnishing, performance, or use of this material. HII disclaims all responsibility for the selection and use of software and/or hardware to achieve intended results.

This document contains proprietary information that is protected by copyright. All rights are reserved. No part of this document may be photocopied, reproduced, or translated into another language without the prior written consent of HII.

© 2009-2015 Honeywell International Inc. All rights reserved.

Other product names or marks mentioned in this document may be trademarks or registered trademarks of other companies and are the property of their respective owners.

Web Address: www.honeywellaidc.com

Patents

For patent information, please refer to www.hsmpats.com.

Technical Assistance

Contact information for technical support, product service, and repair can be found at www.honeywellaidc.com.

Limited Warranty

Refer to www.honeywellaidc.com/warranty_information for your product's warranty information.

User Documentation

To download user documentation go to www.honeywellaidc.com.